



### flowPACK E1

1200 V / 35 A

#### Topology features

- Open Emitter configuration
- Temperature sensor
- Inverter
- Low side Kelvin Emitter for improved switching performance

#### Component features

- Easy paralleling
- Low turn-off losses
- Low collector emitter saturation voltage
- Positive temperature coefficient
- Short tail current
- Switching optimized for EMC

#### Housing features

- Base isolation: Al<sub>2</sub>O<sub>3</sub>
- Convex shaped substrate for superior thermal contact
- Compact housing
- CTI600 housing material
- Thermo-mechanical push-and-pull force relief
- Press-fit pin
- Reliable cold welding connection

#### Extra features

- Equivalent: IFX FS35R12W1T4\_B11

#### Target applications

- Industrial Drives

#### Types

- 10-EZ126PA035M7-L859F78T

#### flow E1 12 mm housing

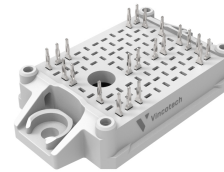

#### Schematic

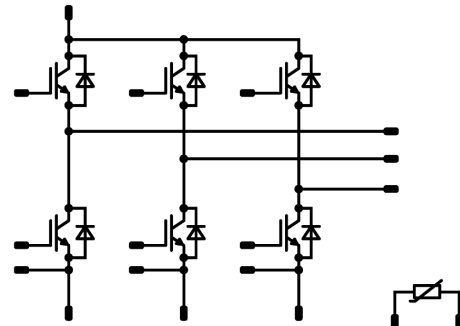



Vincotech

**10-EZ126PA035M7-L859F78T**  
datasheet

## Maximum Ratings

$T_j = 25\text{ °C}$ , unless otherwise specified

| Parameter                         | Symbol     | Conditions   | Value    | Unit               |
|-----------------------------------|------------|--|----------|--------------------|
| <b>Inverter Switch</b>            |            |  |          |                    |
| Collector-emitter voltage         | $V_{CES}$  |  | 1200     | V                  |
| Collector current (DC current)    | $I_C$      | $T_j = T_{jmax}$ $T_s = 80\text{ °C}$                                  | 51       | A                  |
| Repetitive peak collector current | $I_{CRM}$  | $t_p$ limited by $T_{jmax}$  | 70       | A                  |
| Total power dissipation           | $P_{tot}$  | $T_j = T_{jmax}$ $T_s = 80\text{ °C}$                                  | 108      | W                  |
| Gate-emitter voltage              | $V_{GES}$  |  | $\pm 20$ | V                  |
| Short circuit ratings             | $i_{SC}$   | $V_{GE} = 15\text{ V}$ , $V_{CC} = 800\text{ V}$ $T_j = 150\text{ °C}$ | 9,5      | $\mu\text{s}$      |
| Maximum junction temperature      | $T_{jmax}$ |  | 175      | $^{\circ}\text{C}$ |

## Inverter Diode

|                                 |            |                                       |      |                    |
|---------------------------------|------------|---------------------------------------|------|--------------------|
| Peak repetitive reverse voltage | $V_{RRM}$  |                                       | 1200 | V                  |
| Forward current (DC current)    | $I_F$      | $T_j = T_{jmax}$ $T_s = 80\text{ °C}$ | 41   | A                  |
| Repetitive peak forward current | $I_{FRM}$  | $t_p$ limited by $T_{jmax}$           | 70   | A                  |
| Total power dissipation         | $P_{tot}$  | $T_j = T_{jmax}$ $T_s = 80\text{ °C}$ | 78   | W                  |
| Maximum junction temperature    | $T_{jmax}$ |                                       | 175  | $^{\circ}\text{C}$ |

## Module Properties

### Thermal Properties

|   |           |  |                            |                    |
|---|-----------|--|----------------------------|--------------------|
| Storage temperature                             | $T_{stg}$ |  | -40...+125                 | $^{\circ}\text{C}$ |
| Operation temperature under switching condition | $T_{jop}$ |  | -40...+( $T_{jmax} - 25$ ) | $^{\circ}\text{C}$ |

### Isolation Properties

|                            |            |                                     |            |    |
|----------------------------|------------|-------------------------------------|------------|----|
| Isolation voltage          | $V_{isol}$ | DC Test Voltage* $t_p = 2\text{ s}$ | 6000       | V  |
| Creepage distance          |            |                                     | >12,7      | mm |
| Clearance                  |            |                                     | 8,62       | mm |
| Comparative Tracking Index | CTI        |                                     | $\geq 600$ |    |

\*100 % tested in production



Vincotech

### Characteristic Values

| Parameter | Symbol | Conditions   |              |              |           |            | Values |     |     | Unit |
|-----------|--------|--------------|--------------|--------------|-----------|------------|--------|-----|-----|------|
|           |        | $V_{GS}$ [V] | $V_{GE}$ [V] | $V_{DS}$ [V] | $I_D$ [A] | $T_j$ [°C] | Min    | Typ | Max |      |

#### Inverter Switch

##### Static

|                                      |               |                  |      |      |        |                  |     |                      |                     |    |
|--------------------------------------|---------------|------------------|------|------|--------|------------------|-----|----------------------|---------------------|----|
| Gate-emitter threshold voltage       | $V_{GE(th)}$  |                  |      | 10   | 0,0035 | 25               | 5,4 | 6                    | 6,6                 | V  |
| Collector-emitter saturation voltage | $V_{CE(sat)}$ |                  | 15   |      | 35     | 25<br>125<br>150 |     | 1,47<br>1,64<br>1,68 | 1,85 <sup>(1)</sup> | V  |
| Collector-emitter cut-off current    | $I_{CES}$     |                  | 0    | 1200 |        | 25               |     |                      | 80                  | μA |
| Gate-emitter leakage current         | $I_{GES}$     |                  | 20   | 0    |        | 25               |     |                      | 200                 | nA |
| Internal gate resistance             | $r_g$         |                  |      |      |        |                  |     | None                 |                     | Ω  |
| Input capacitance                    | $C_{ies}$     |                  |      |      |        |                  |     | 7900                 |                     | pF |
| Output capacitance                   | $C_{oes}$     |                  | 0    | 10   |        | 25               |     | 270                  |                     | pF |
| Reverse transfer capacitance         | $C_{res}$     |                  |      |      |        |                  |     | 97                   |                     | pF |
| Gate charge                          | $Q_g$         | $V_{CC} = 600$ V | 0/15 |      | 35     | 25               |     | 260                  |                     | nC |

##### Thermal

|  |               |                                    |  |  |  |  |  |      |  |     |
|--|---------------|------------------------------------|--|--|--|--|--|------|--|-----|
| Thermal resistance junction to sink <sup>(2)</sup> | $R_{th(j-s)}$ | $\lambda_{paste} = 3,4$ W/mK (PSX) |  |  |  |  |  | 0,88 |  | K/W |
|--|---------------|------------------------------------|--|--|--|--|--|------|--|-----|

##### Dynamic

|                             |              |   |  |  |  |                  |  |                           |  |     |
|-----------------------------|--------------|---|--|--|--|------------------|--|---------------------------|--|-----|
| Turn-on delay time          | $t_{d(on)}$  |   |  |  |  | 25<br>125<br>150 |  | 223,4<br>240,2<br>233     |  | ns  |
| Rise time                   | $t_r$        |   |  |  |  | 25<br>125<br>150 |  | 28<br>34<br>35,2          |  | ns  |
| Turn-off delay time         | $t_{d(off)}$ |   |  |  |  | 25<br>125<br>150 |  | 227<br>252,2<br>259,4     |  | ns  |
| Fall time                   | $t_f$        |   |  |  |  | 25<br>125<br>150 |  | 96,87<br>114,26<br>122,62 |  | ns  |
| Turn-on energy (per pulse)  | $E_{on}$     | $Q_{tFWD} = 3,8$ μC<br>$Q_{tFWD} = 5,84$ μC<br>$Q_{tFWD} = 6,39$ μC |  |  |  | 25<br>125<br>150 |  | 2,45<br>3,23<br>3,44      |  | mWs |
| Turn-off energy (per pulse) | $E_{off}$    |   |  |  |  | 25<br>125<br>150 |  | 2,46<br>3,24<br>3,46      |  | mWs |



### Characteristic Values

| Parameter  | Symbol            | Conditions  |   |                                     |            |                  | Values |                            |                    | Unit |
|--|-------------------|---|---|-------------------------------------|------------|------------------|--------|----------------------------|--------------------|------|
|  |                   | $V_{GE}$ [V]<br>$V_{GS}$ [V]                                | $V_{CE}$ [V]<br>$V_{DS}$ [V]<br>$V_F$ [V] | $I_C$ [A]<br>$I_D$ [A]<br>$I_F$ [A] | $T_j$ [°C] | Min              | Typ    | Max                        |                    |      |
| <b>Inverter Diode</b>                              |                   |   |   |                                     |            |                  |        |                            |                    |      |
| <b>Static</b>                                      |                   |   |   |                                     |            |                  |        |                            |                    |      |
| Forward voltage                                    | $V_F$             |   |   |                                     | 35         | 25<br>125<br>150 |        | 1,66<br>1,76<br>1,75       | 2,1 <sup>(1)</sup> | V    |
| Reverse leakage current                            | $I_R$             | $V_r = 1200$ V  |   |                                     |            | 25               |        |                            | 40                 | μA   |
| <b>Thermal</b>                                     |                   |   |   |                                     |            |                  |        |                            |                    |      |
| Thermal resistance junction to sink <sup>(2)</sup> | $R_{th(j-s)}$     | $\lambda_{paste} = 3,4$ W/mK<br>(PSX)                       |   |                                     |            |                  |        | 1,22                       |                    | K/W  |
| <b>Dynamic</b>                                     |                   |   |   |                                     |            |                  |        |                            |                    |      |
| Peak recovery current                              | $I_{RM}$          |   |   |                                     |            | 25<br>125<br>150 |        | 41,09<br>40,2<br>40,64     |                    | A    |
| Reverse recovery time                              | $t_{rr}$          |   |   |                                     |            | 25<br>125<br>150 |        | 266,56<br>425,38<br>450,01 |                    | ns   |
| Recovered charge                                   | $Q_r$             | $di/dt=1364$ A/μs<br>$di/dt=1192$ A/μs<br>$di/dt=1157$ A/μs | ±15                                       | 600                                 | 35         | 25<br>125<br>150 |        | 3,8<br>5,84<br>6,39        |                    | μC   |
| Reverse recovered energy                           | $E_{rec}$         |   |   |                                     |            | 25<br>125<br>150 |        | 1,48<br>2,39<br>2,6        |                    | mWs  |
| Peak rate of fall of recovery current              | $(di_r/dt)_{max}$ |   |   |                                     |            | 25<br>125<br>150 |        | 485,16<br>353,08<br>342,83 |                    | A/μs |



Vincotech

### Characteristic Values

| Parameter | Symbol | Conditions   |              |              |              |            | Values |     |     | Unit |
|-----------|--------|--------------|--------------|--------------|--------------|------------|--------|-----|-----|------|
|           |        | $V_{GS}$ [V] | $V_{GE}$ [V] | $V_{DS}$ [V] | $V_{CE}$ [V] | $T_j$ [°C] | Min    | Typ | Max |      |

### Thermistor

#### Static

|                                |                |                        |  |  |  |     |    |      |   |      |
|--------------------------------|----------------|------------------------|--|--|--|-----|----|------|---|------|
| Rated resistance               | $R$            |                        |  |  |  | 25  |    | 5    |   | kΩ   |
| Deviation of R100              | $A_{R/R}$      | $R_{100} = 493 \Omega$ |  |  |  | 100 | -5 |      | 5 | %    |
| Power dissipation              | $P$            |                        |  |  |  |     |    | 245  |   | mW   |
| Power dissipation constant     | $d$            |                        |  |  |  | 25  |    | 1,4  |   | mW/K |
| B-value                        | $B_{(25/50)}$  | Tol. $\pm 2 \%$        |  |  |  |     |    | 3375 |   | K    |
| B-value                        | $B_{(25/100)}$ | Tol. $\pm 2 \%$        |  |  |  |     |    | 3437 |   | K    |
| Vincotech Thermistor Reference |                |                        |  |  |  |     |    |      | K |      |

<sup>(1)</sup> Value at chip level

<sup>(2)</sup> Only valid with pre-applied Vincotech thermal interface material.



## Inverter Switch Characteristics

figure 1. IGBT

Typical output characteristics

$$I_C = f(V_{CE})$$

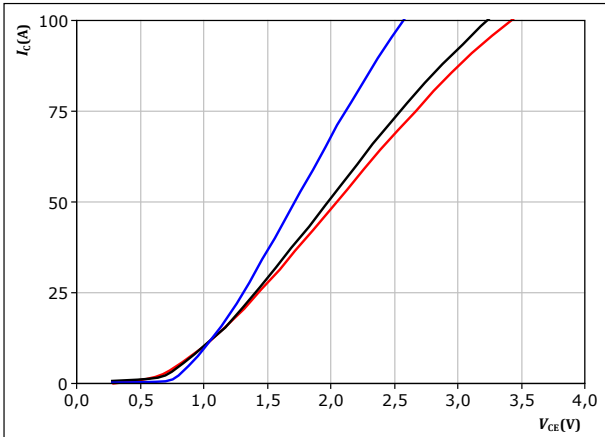

$t_p = 250 \mu s$   
 $V_{GE} = 15 V$   
 $T_j:$  — 25 °C  
— 125 °C  
— 150 °C

figure 2. IGBT

Typical output characteristics

$$I_C = f(V_{CE})$$

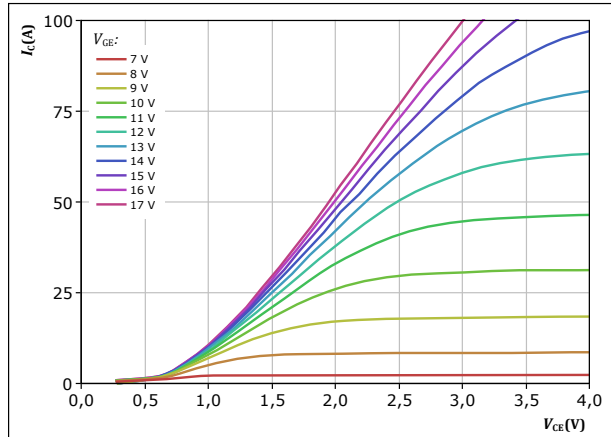

$t_p = 250 \mu s$   
 $T_j = 150 \text{ °C}$   
 $V_{GE}$  from 7 V to 17 V in steps of 1 V

figure 3. IGBT

Typical transfer characteristics

$$I_C = f(V_{GE})$$

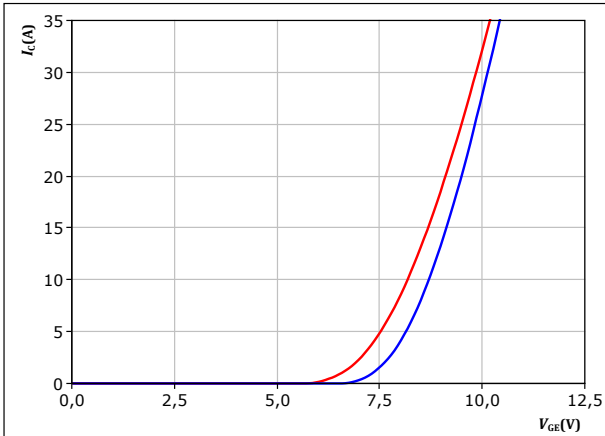

$t_p = 250 \mu s$   
 $V_{CE} = 10 V$   
 $T_j:$  — 25 °C  
— 125 °C

figure 4. IGBT

Transient thermal impedance as a function of pulse width

$$Z_{th(j-s)} = f(t_p)$$

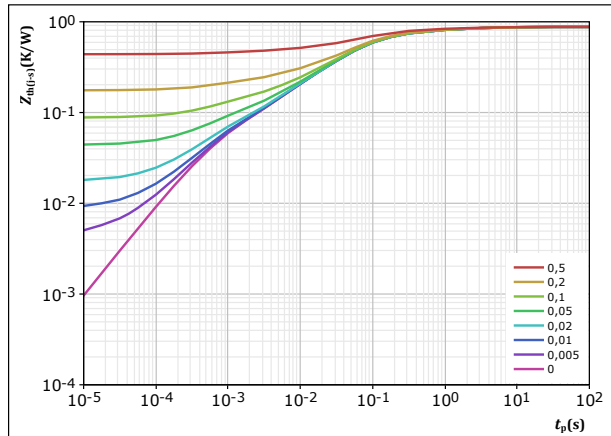

$D = t_p / T$   
 $R_{th(j-s)} = 0,878 \text{ K/W}$   
IGBT thermal model values  

| R (K/W)  | $\tau$ (s) |
|----------|------------|
| 4,21E-02 | 5,44E+00   |
| 8,81E-02 | 8,75E-01   |
| 2,30E-01 | 1,59E-01   |
| 3,79E-01 | 4,61E-02   |
| 9,10E-02 | 6,73E-03   |
| 4,73E-02 | 6,45E-04   |



## Inverter Switch Characteristics

figure 5. IGBT

Safe operating area

$$I_C = f(V_{CE})$$

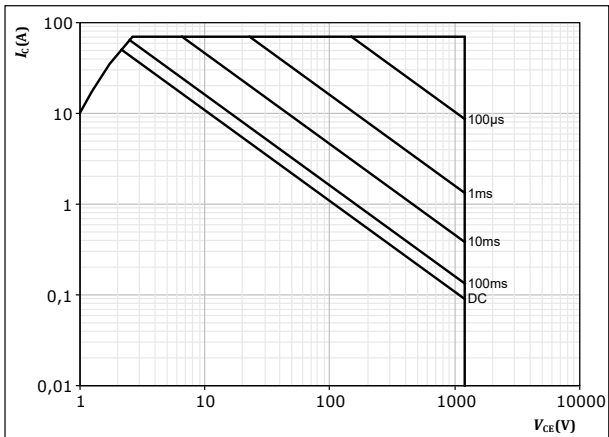

$D =$  single pulse  
 $T_s = 80$  °C  
 $V_{GE} = 15$  V  
 $T_j = T_{jmax}$

figure 6. IGBT

Gate voltage vs gate charge

$$V_{GE} = f(Q_g)$$

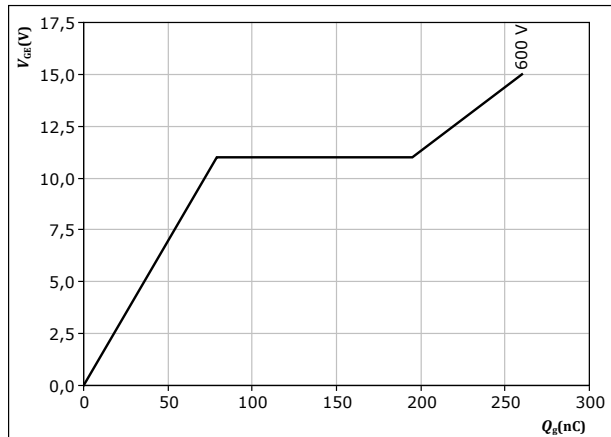

$I_C = 35$  A  
 $T_j = 25$  °C



### Inverter Diode Characteristics

figure 7. FWD

Typical forward characteristics

$$I_F = f(V_F)$$

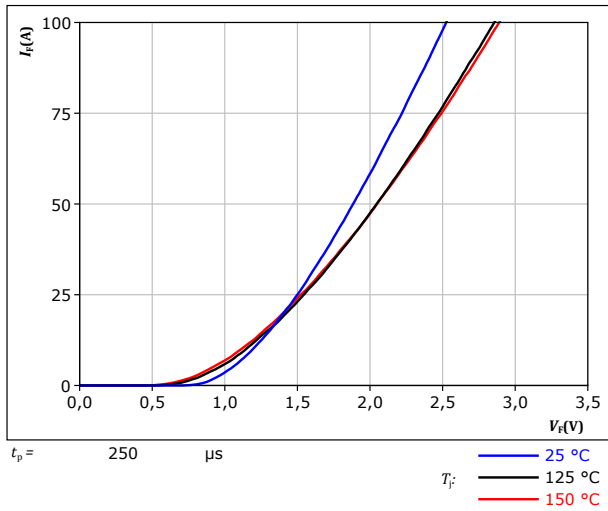
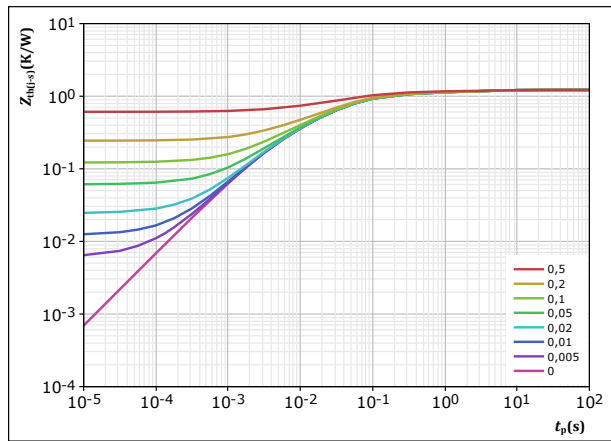

figure 8. FWD

Transient thermal impedance as a function of pulse width

$$Z_{th(j-s)} = f(t_p)$$



$D = t_p / T$   
 $R_{th(j-s)} = 1,219 \text{ K/W}$   
 FWD thermal model values

| $R$ (K/W) | $\tau$ (s) |
|-----------|------------|
| 1,07E-01  | 3,56E+00   |
| 1,60E-01  | 2,77E-01   |
| 5,76E-01  | 5,00E-02   |
| 2,75E-01  | 1,24E-02   |
| 1,01E-01  | 2,87E-03   |





### Thermistor Characteristics

figure 9. Thermistor

Typical NTC characteristic as function of temperature  
 $R_T = f(T)$

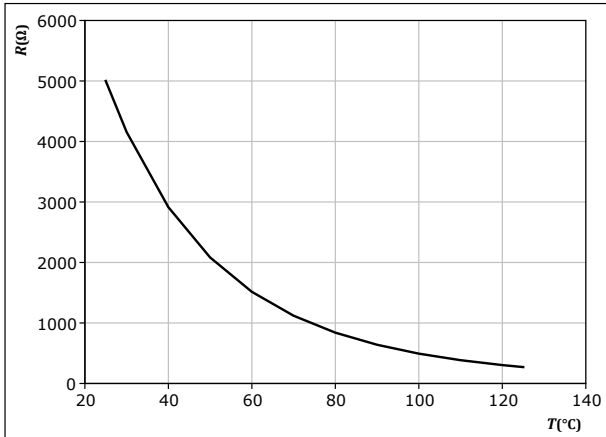



## Inverter Switching Characteristics

**figure 10.** IGBT

Typical switching energy losses as a function of collector current  
 $E = f(I_c)$

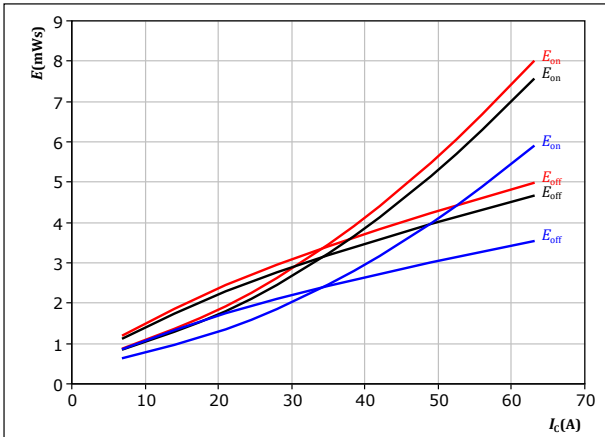

With an inductive load at  
 $V_{CE} = 600 \text{ V}$   
 $V_{GE} = \pm 15 \text{ V}$   
 $R_{gon} = 16 \text{ } \Omega$   
 $R_{goff} = 16 \text{ } \Omega$   
 $T_j$ : 25 °C (blue), 125 °C (black), 150 °C (red)

**figure 11.** IGBT

Typical switching energy losses as a function of IGBT turn on gate resistor  
 $E = f(R_g)$

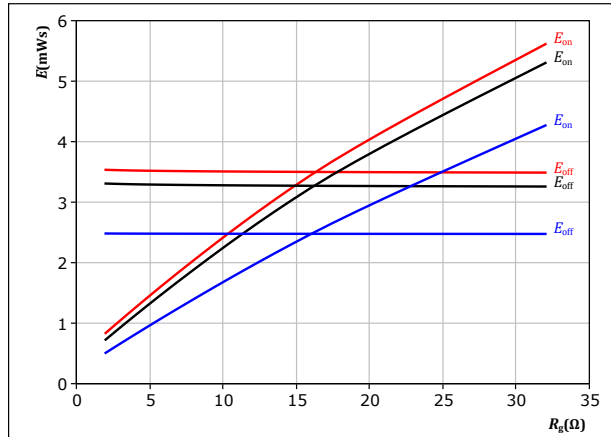

With an inductive load at  
 $V_{CE} = 600 \text{ V}$   
 $V_{GE} = \pm 15 \text{ V}$   
 $I_c = 35 \text{ A}$   
 $T_j$ : 25 °C (blue), 125 °C (black), 150 °C (red)

**figure 12.** FWD

Typical reverse recovered energy loss as a function of collector current  
 $E_{rec} = f(I_c)$

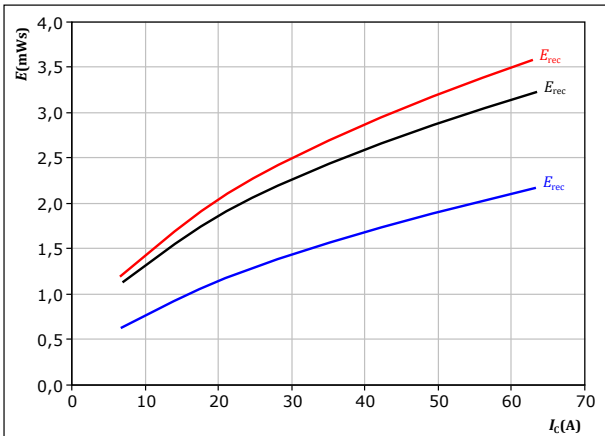

With an inductive load at  
 $V_{CE} = 600 \text{ V}$   
 $V_{GE} = \pm 15 \text{ V}$   
 $R_{gon} = 16 \text{ } \Omega$   
 $T_j$ : 25 °C (blue), 125 °C (black), 150 °C (red)

**figure 13.** FWD

Typical reverse recovered energy loss as a function of IGBT turn on gate resistor  
 $E_{rec} = f(R_g)$

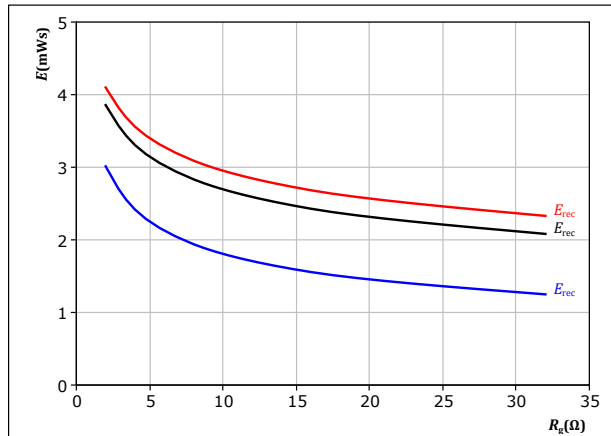

With an inductive load at  
 $V_{CE} = 600 \text{ V}$   
 $V_{GE} = \pm 15 \text{ V}$   
 $I_c = 35 \text{ A}$   
 $T_j$ : 25 °C (blue), 125 °C (black), 150 °C (red)



## Inverter Switching Characteristics

**figure 14.** IGBT

Typical switching times as a function of collector current  
 $t = f(I_c)$

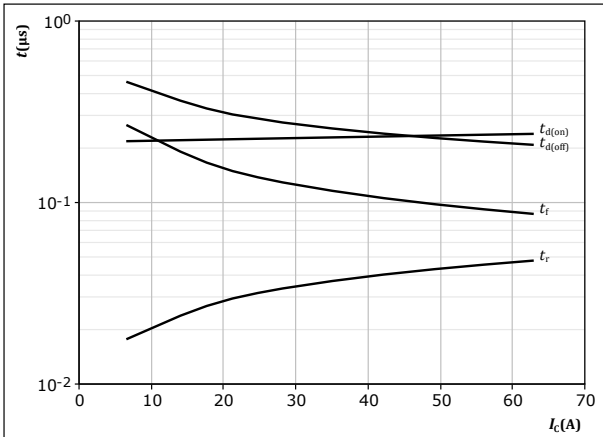

With an inductive load at  
 $T_j = 150$  °C  
 $V_{CE} = 600$  V  
 $V_{GE} = \pm 15$  V  
 $R_{gon} = 16$  Ω  
 $R_{goff} = 16$  Ω

**figure 15.** IGBT

Typical switching times as a function of IGBT turn on gate resistor  
 $t = f(R_g)$

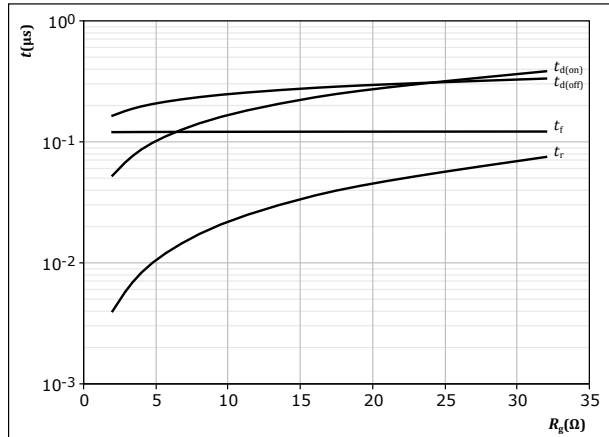

With an inductive load at  
 $T_j = 150$  °C  
 $V_{CE} = 600$  V  
 $V_{GE} = \pm 15$  V  
 $I_c = 35$  A

**figure 16.** FWD

Typical reverse recovery time as a function of collector current  
 $t_{rr} = f(I_c)$

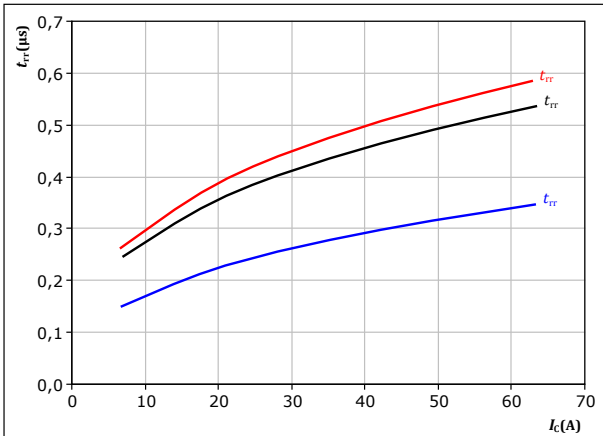

With an inductive load at  
 $V_{CE} = 600$  V  
 $V_{GE} = \pm 15$  V  
 $R_{gon} = 16$  Ω  
 $T_j$ : — 25 °C  
— 125 °C  
— 150 °C

**figure 17.** FWD

Typical reverse recovery time as a function of IGBT turn on gate resistor  
 $t_{rr} = f(R_{gon})$

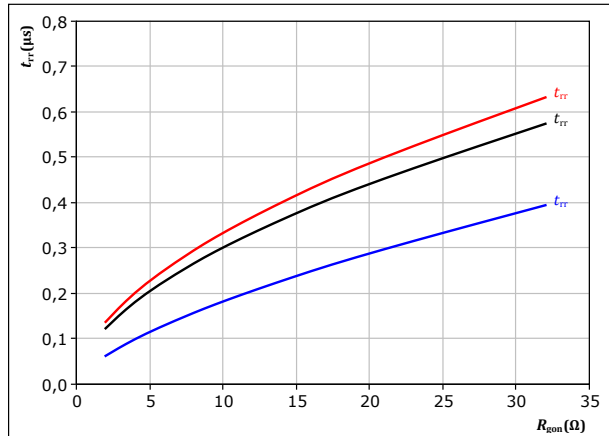

With an inductive load at  
 $V_{CE} = 600$  V  
 $V_{GE} = \pm 15$  V  
 $I_c = 35$  A  
 $T_j$ : — 25 °C  
— 125 °C  
— 150 °C



## Inverter Switching Characteristics

figure 18. FWD

Typical recovered charge as a function of collector current

$$Q_r = f(I_c)$$

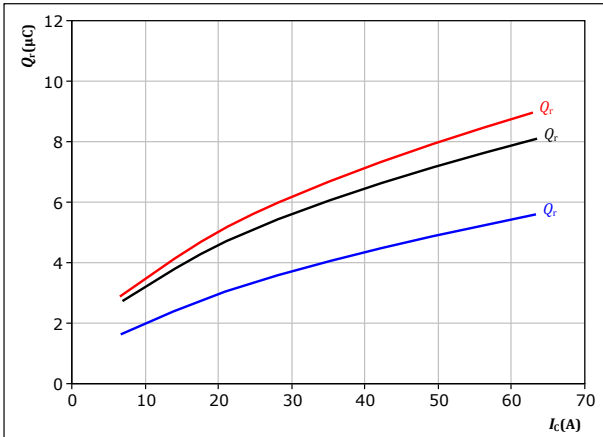

With an inductive load at

$V_{CE} = 600 \text{ V}$   
 $V_{GE} = \pm 15 \text{ V}$   
 $R_{gon} = 16 \text{ } \Omega$

$T_j$ : — 25 °C  
 — 125 °C  
 — 150 °C

figure 19. FWD

Typical recovered charge as a function of IGBT turn on gate resistor

$$Q_r = f(R_{gon})$$

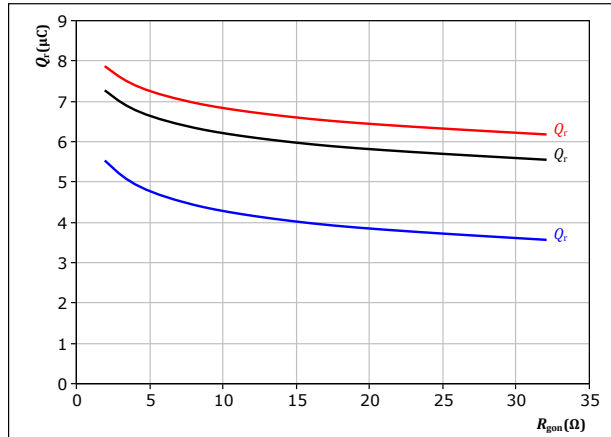

With an inductive load at

$V_{CE} = 600 \text{ V}$   
 $V_{GE} = \pm 15 \text{ V}$   
 $I_c = 35 \text{ A}$

$T_j$ : — 25 °C  
 — 125 °C  
 — 150 °C

figure 20. FWD

Typical peak reverse recovery current as a function of collector current

$$I_{RM} = f(I_c)$$

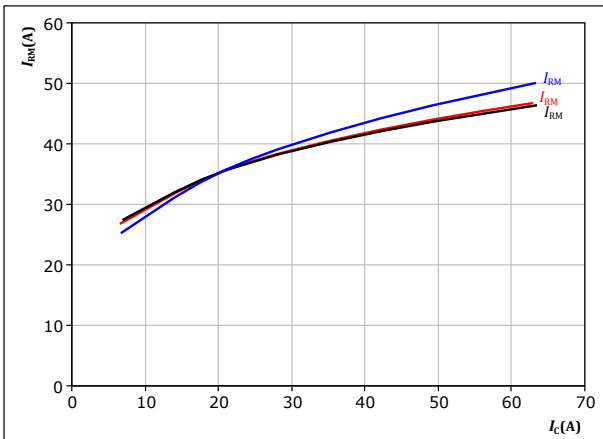

With an inductive load at

$V_{CE} = 600 \text{ V}$   
 $V_{GE} = \pm 15 \text{ V}$   
 $R_{gon} = 16 \text{ } \Omega$

$T_j$ : — 25 °C  
 — 125 °C  
 — 150 °C

figure 21. FWD

Typical peak reverse recovery current as a function of IGBT turn on gate resistor

$$I_{RM} = f(R_{gon})$$

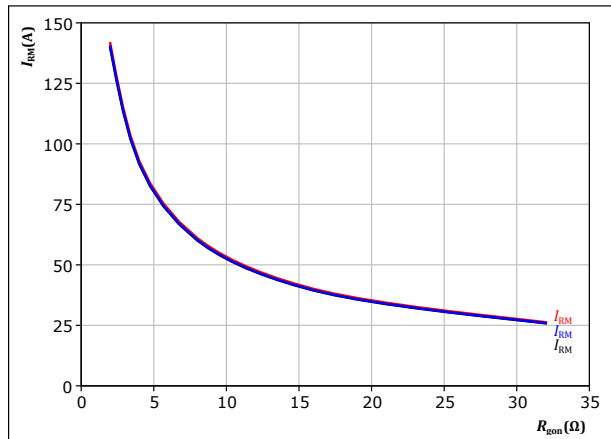

With an inductive load at

$V_{CE} = 600 \text{ V}$   
 $V_{GE} = \pm 15 \text{ V}$   
 $I_c = 35 \text{ A}$

$T_j$ : — 25 °C  
 — 125 °C  
 — 150 °C



## Inverter Switching Characteristics

**figure 22.** FWD

Typical rate of fall of forward and reverse recovery current as a function of collector current  
 $di_f/dt, di_{rr}/dt = f(I_C)$

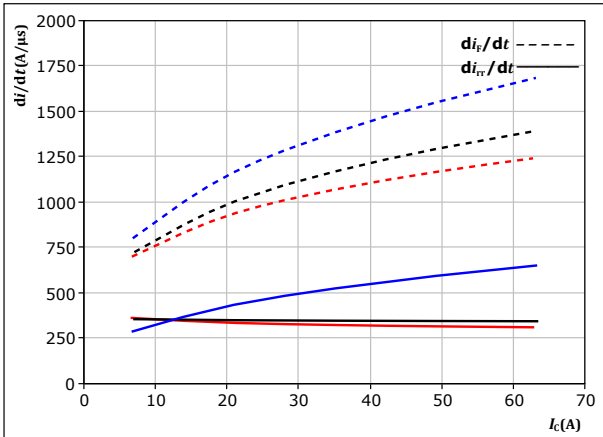

With an inductive load at

|                     |                |
|---------------------|----------------|
| $V_{CE} = 600$ V    | $T_j = 25$ °C  |
| $V_{GE} = \pm 15$ V | $T_j = 125$ °C |
| $R_{gon} = 16$ Ω    | $T_j = 150$ °C |

**figure 23.** FWD

Typical rate of fall of forward and reverse recovery current as a function of turn on gate resistor  
 $di_f/dt, di_{rr}/dt = f(R_{gon})$

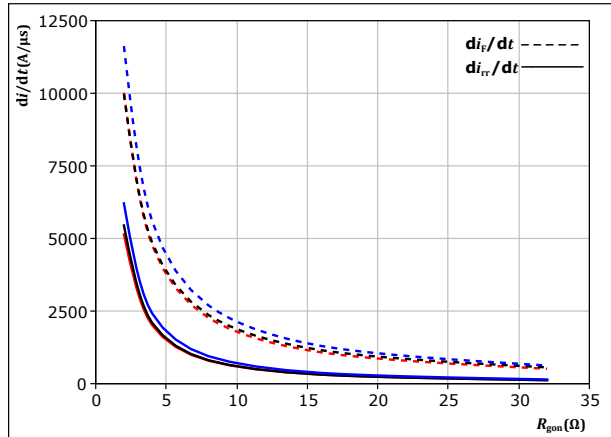

With an inductive load at

|                     |                |
|---------------------|----------------|
| $V_{CE} = 600$ V    | $T_j = 25$ °C  |
| $V_{GE} = \pm 15$ V | $T_j = 125$ °C |
| $I_C = 35$ A        | $T_j = 150$ °C |

**figure 24.** IGBT

Reverse bias safe operating area  
 $I_C = f(V_{CE})$

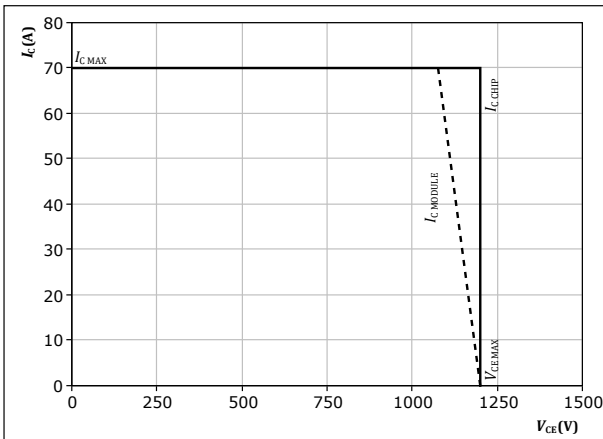

At  $T_j = 150$  °C  
 $R_{gon} = 16$  Ω  
 $R_{goff} = 16$  Ω



## Inverter Switching Definitions

**figure 25.** IGBT

Turn-off Switching Waveforms & definition of  $t_{doff}$ ,  $t_{Eoff}$  ( $t_{Eoff}$  = integrating time for  $E_{off}$ )

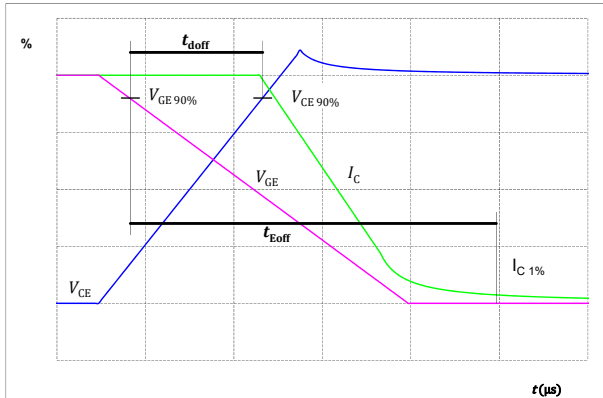

**figure 26.** IGBT

Turn-on Switching Waveforms & definition of  $t_{don}$ ,  $t_{Eon}$  ( $t_{Eon}$  = integrating time for  $E_{on}$ )

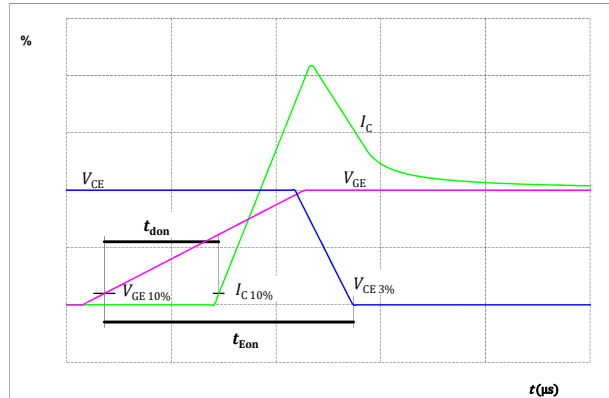

**figure 27.** IGBT

Turn-off Switching Waveforms & definition of  $t_f$

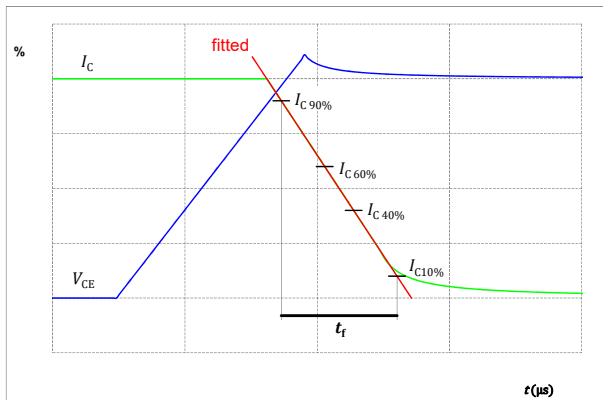

**figure 28.** IGBT

Turn-on Switching Waveforms & definition of  $t_r$

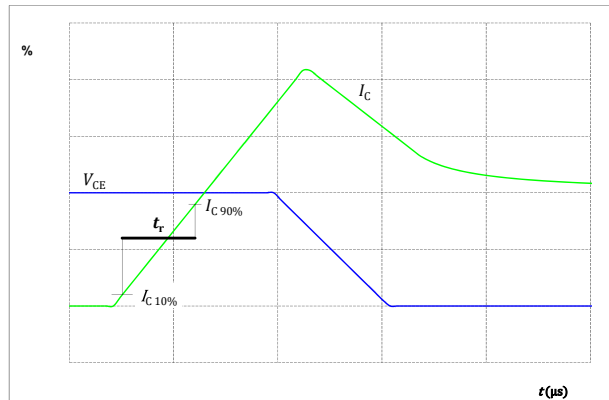



### Inverter Switching Definitions

figure 29. FWD

Turn-off Switching Waveforms & definition of  $t_{rr}$

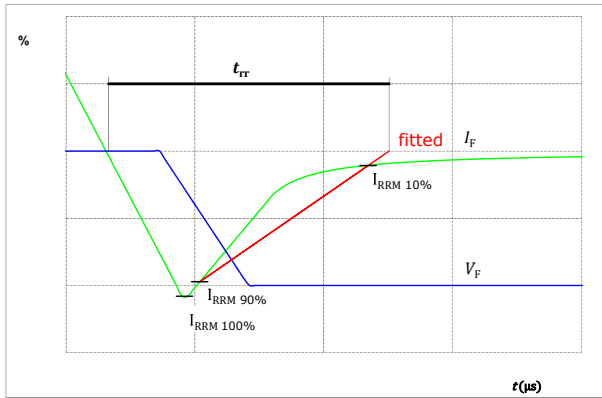
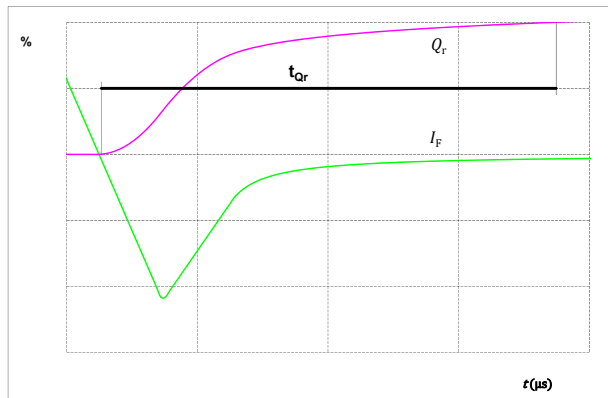

figure 30. FWD

Turn-on Switching Waveforms & definition of  $t_{Qr}$  ( $t_{Qr}$  = integrating time for  $Q_r$ )





Vincotech

**10-EZ126PA035M7-L859F78T**  
datasheet

| Ordering Code                            |                              |
|--|------------------------------|
| <b>Version</b>                           | <b>Ordering Code</b>         |
| Without thermal paste                    | 10-EZ126PA035M7-L859F78T     |
| With thermal paste (5,2 W/mK, PTM6000HV) | 10-EZ126PA035M7-L859F78T-/7/ |

| Marking   |                   |   |                            |                               |                          |                       |
|---|-------------------|---|----------------------------|-------------------------------|--------------------------|-----------------------|
|  | <b>Text</b>       | <b>Name</b><br>NN-NNNNNNNNNNNNNN-<br>TTTTTV | <b>Date code</b><br>WWYY   | <b>UL &amp; VIN</b><br>UL VIN | <b>Lot</b><br>LLLLL      | <b>Serial</b><br>SSSS |
|   | <b>Datamatrix</b> | <b>Type&amp;Ver</b><br>TTTTTTTV             | <b>Lot number</b><br>LLLLL | <b>Serial</b><br>SSSS         | <b>Date code</b><br>WWYY |                       |

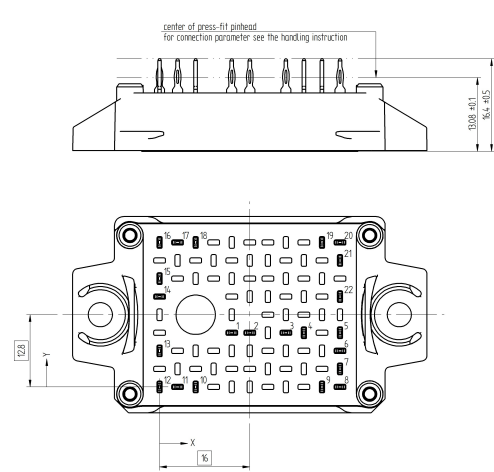
| Pin table [mm] |      |      |          | Outline   |  |
|----------------|------|------|----------|---|--|
| Pin            | X    | Y    | Function |  |  |
| 1              | 12,8 | 9,6  | DC+      |   |  |
| 2              | 16   | 9,6  | DC+      |   |  |
| 3              | 22,4 | 9,6  | Therm1   |   |  |
| 4              | 25,6 | 9,6  | Therm2   |   |  |
| 5              | 32   | 9,6  | DC-2     |   |  |
| 6              | 32   | 6,4  | S13      |   |  |
| 7              | 32   | 3,2  | DC-1     |   |  |
| 8              | 32   | 0    | S11      |   |  |
| 9              | 28,8 | 0    | G11      |   |  |
| 10             | 6,4  | 0    | Ph1      |   |  |
| 11             | 3,2  | 0    | Ph1      |   |  |
| 12             | 0    | 0    | G12      |   |  |
| 13             | 0    | 6,4  | G14      |   |  |
| 14             | 0    | 16   | Ph2      |   |  |
| 15             | 0    | 19,2 | Ph2      |   |  |
| 16             | 0    | 25,6 | G16      |   |  |
| 17             | 3,2  | 25,6 | Ph3      |   |  |
| 18             | 6,4  | 25,6 | Ph3      |   |  |
| 19             | 28,8 | 25,6 | G15      |   |  |
| 20             | 32   | 25,6 | S15      |   |  |
| 21             | 32   | 22,4 | DC-3     |   |  |
| 22             | 32   | 16   | G13      |   |  |

Tolerance of pinpositions: ±0.4mm at the end of pins.  
Dimension of coordinate axis is only official without tolerance





Vincotech

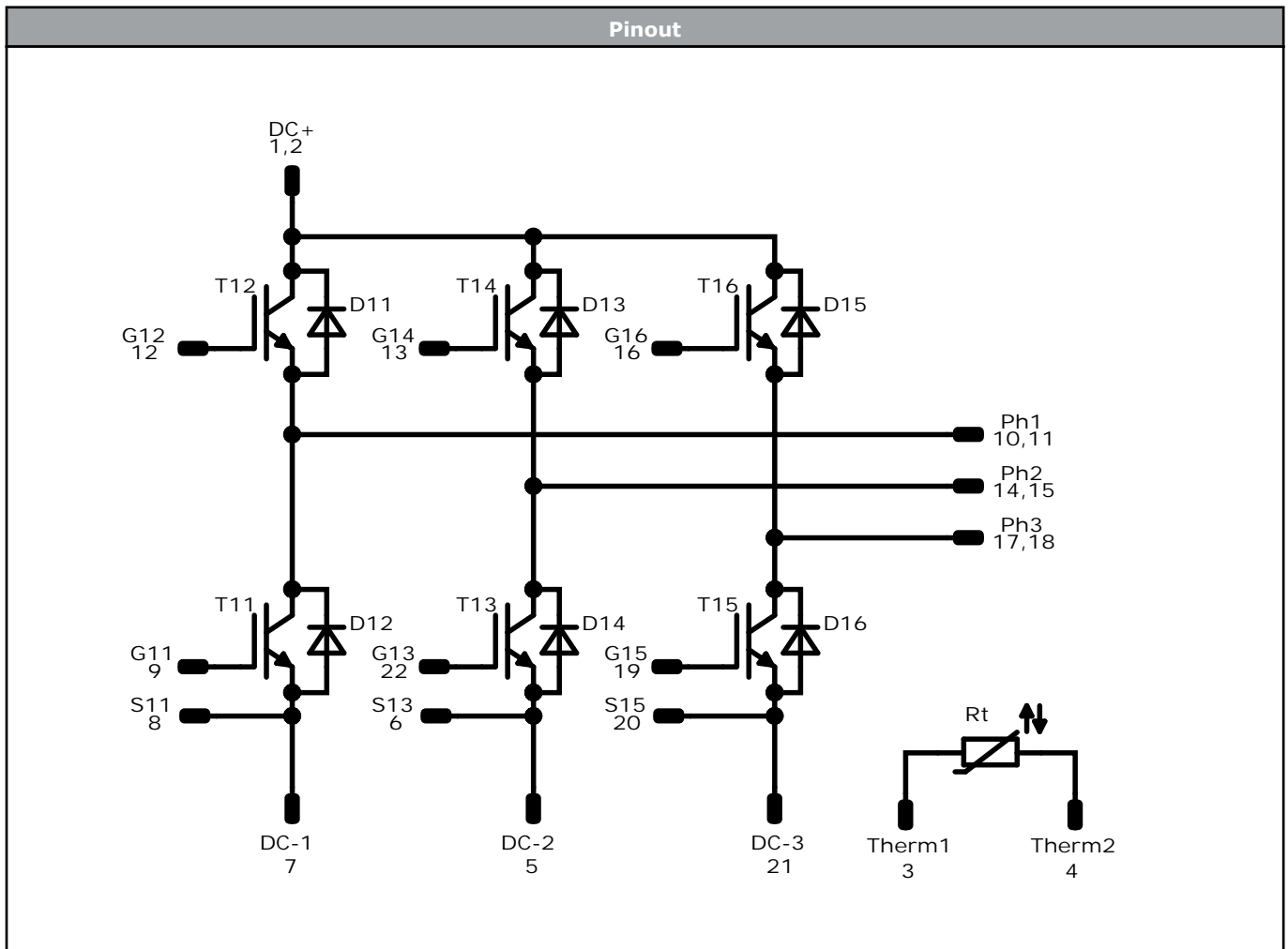

| Identification               |           |         |         |                 |         |
|------------------------------|-----------|---------|---------|-----------------|---------|
| ID                           | Component | Voltage | Current | Function        | Comment |
| T11, T12, T13, T14, T15, T16 | IGBT      | 1200 V  | 35 A    | Inverter Switch |         |
| D11, D12, D13, D14, D15, D16 | FWD       | 1200 V  | 35 A    | Inverter Diode  |         |
| Rt                           | NTC       |         |         | Thermistor      |         |



| Packaging instruction                 |      |          |      |        |
|---------------------------------------|------|----------|------|--------|
| Standard packaging quantity (SPQ) 100 | >SPQ | Standard | <SPQ | Sample |

| Handling instruction   |
|--|
| Handling instructions for <i>flow</i> E1 packages see vincotech.com website. |

| Package data  |
|---|
| Package data for <i>flow</i> E1 packages see vincotech.com website. |

| Vincotech thermistor reference                                     |
|--|
| See Vincotech thermistor reference table at vincotech.com website. |

| UL recognition and file number   |
|--|
| This device is UL 1557 recognized under E192116 up to a junction temperature under switching condition $T_{j,op}=175^{\circ}C$ and up to 3500VAC/1min isolation voltage. For more information see vincotech.com website. |



| Document No.:                  | Date:       | Modification:       | Pages |
|--------------------------------|-------------|---------------------|-------|
| 10-EZ126PA035M7-L859F78T-D5-14 | 6 Dec. 2024 | Add option code /7/ |       |

**DISCLAIMER**

The information, specifications, procedures, methods and recommendations herein (together "information") are presented by Vincotech to reader in good faith, are believed to be accurate and reliable, but may well be incomplete and/or not applicable to all conditions or situations that may exist or occur. Vincotech reserves the right to make any changes without further notice to any products to improve reliability, function or design. No representation, guarantee or warranty is made to reader as to the accuracy, reliability or completeness of said information or that the application or use of any of the same will avoid hazards, accidents, losses, damages or injury of any kind to persons or property or that the same will not infringe third parties rights or give desired results. It is reader's sole responsibility to test and determine the suitability of the information and the product for reader's intended use.

**LIFE SUPPORT POLICY**

Vincotech products are not authorised for use as critical components in life support devices or systems without the express written approval of Vincotech.

As used herein:

1. Life support devices or systems are devices or systems which, (a) are intended for surgical implant into the body, or (b) support or sustain life, or (c) whose failure to perform when properly used in accordance with instructions for use provided in labelling can be reasonably expected to result in significant injury to the user.
2. A critical component is any component of a life support device or system whose failure to perform can be reasonably expected to cause the failure of the life support device or system, or to affect its safety or effectiveness.