



flowNPC E3BP

1200 V / 600 A

Topology features

- Low side Kelvin Emitter for improved switching performance
- Neutral Point Clamped Topology (I-Type)
- Split topology
- Temperature sensor

Component features

- High speed switching
- Low collector emitter saturation voltage
- Low turn-off losses
- Optimized for hard switching topologies
- Positive temperature coefficient

Housing features

- Base isolation: Al₂O₃
- Cu baseplate
- Convex shaped baseplate for superior thermal contact
- CTI600 housing material
- Baseplate with rough surface
- Press-fit pin
- Reliable cold welding connection
- Thermo-mechanical push-and-pull force relief

Target applications

- Solar Inverters

Types

- 30-EP12NIA600H703-PM00F83T

flow E3BP 12 mm housing

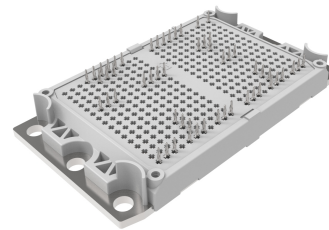

Schematic

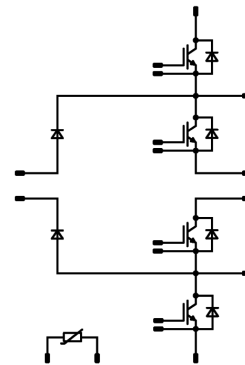



Vincotech

Maximum Ratings

$T_j = 25\text{ °C}$, unless otherwise specified

Parameter	Symbol	Conditions	Value	Unit
Buck Switch				
Collector-emitter voltage	V_{CES}		1200	V
Collector current (DC current)	I_C	$T_j = T_{jmax}$ $T_s = 80\text{ °C}$	375	A
Repetitive peak collector current	I_{CRM}	t_p limited by T_{jmax}	1800	A
Turn off safe operating area		$T_j = 150\text{ °C}$, $V_{CE} = 1200\text{ V}$	1800	A
Total power dissipation	P_{tot}	$T_j = T_{jmax}$ $T_s = 80\text{ °C}$	708	W
Gate-emitter voltage	V_{GES}		± 20	V
Maximum junction temperature	T_{jmax}		175	°C

Buck Diode

Peak repetitive reverse voltage	V_{RRM}		1200	V
Forward current (DC current)	I_F	$T_j = T_{jmax}$ $T_s = 80\text{ °C}$	174	A
Repetitive peak forward current	I_{FRM}	t_p limited by T_{jmax}	320	A
Surge (non-repetitive) forward current	I_{FSM}	$t_p = 10\text{ }\mu\text{s}$ $T_j = 25\text{ °C}$	8000	A
Total power dissipation	P_{tot}	$T_j = T_{jmax}$ $T_s = 80\text{ °C}$	365	W
Maximum junction temperature	T_{jmax}		175	°C

Boost Switch

Collector-emitter voltage	V_{CES}		1200	V
Collector current (DC current)	I_C	$T_j = T_{jmax}$ $T_s = 80\text{ °C}$	298	A
Repetitive peak collector current	I_{CRM}	t_p limited by T_{jmax}	800	A
Total power dissipation	P_{tot}	$T_j = T_{jmax}$ $T_s = 80\text{ °C}$	551	W
Gate-emitter voltage	V_{GES}		± 20	V
Short circuit ratings	i_{SC}	$V_{GE} = 15\text{ V}$, $V_{CC} = 800\text{ V}$ $T_j = 150\text{ °C}$	9,5	μs
Maximum junction temperature	T_{jmax}		175	°C



Vincotech

Maximum Ratings

$T_j = 25\text{ °C}$, unless otherwise specified

Parameter	Symbol	Conditions	Value	Unit
Boost Diode				
Peak repetitive reverse voltage	V_{RRM}		1200	V
Forward current (DC current)	I_F	$T_j = T_{jmax}$ $T_s = 80\text{ °C}$	110	A
Repetitive peak forward current	I_{FRM}	t_p limited by T_{jmax}	600	A
Total power dissipation	P_{tot}	$T_j = T_{jmax}$ $T_s = 80\text{ °C}$	196	W
Maximum junction temperature	T_{jmax}		175	°C

Boost Sw. Inv. Diode

Peak repetitive reverse voltage	V_{RRM}		1200	V
Forward current (DC current)	I_F	$T_j = T_{jmax}$ $T_s = 80\text{ °C}$	110	A
Repetitive peak forward current	I_{FRM}	t_p limited by T_{jmax}	600	A
Total power dissipation	P_{tot}	$T_j = T_{jmax}$ $T_s = 80\text{ °C}$	196	W
Maximum junction temperature	T_{jmax}		175	°C

Module Properties

Thermal Properties

Storage temperature	T_{stg}		-40...+125	°C
Operation temperature under switching condition	T_{jop}		-40...+($T_{jmax} - 25$)	°C

Isolation Properties

Isolation voltage	V_{isol}	DC Test Voltage* $t_p = 2\text{ s}$	6000	V
Creepage distance			>12,7	mm
Clearance			>12,7	mm
Comparative Tracking Index	CTI		≥ 600	

*100 % tested in production



Vincotech

30-EP12NIA600H703-PM00F83T
datasheet

Characteristic Values

Parameter	Symbol	Conditions					Values			Unit
		V_{GE} [V] V_{GS} [V]	V_{CE} [V] V_{DS} [V] V_F [V]	I_C [A] I_D [A] I_F [A]	T_j [°C]	Min	Typ	Max		

Buck Switch

Static

Gate-emitter threshold voltage	$V_{GE(th)}$	$V_{CE} = V_{GE}$			0,0096	25	4,7	5,5	6,2	V
Collector-emitter saturation voltage	$V_{CE(sat)}$		15		600	25 125 150		1,84 2,12 2,2	2,15 ⁽¹⁾	V
Collector-emitter cut-off current	I_{CES}		0	1200		25			32	μA
Gate-emitter leakage current	I_{GES}		20	0		25			800	nA
Internal gate resistance	r_g							None		Ω
Input capacitance	C_{ies}							76800		pF
Output capacitance	C_{oes}	$f = 100$ kHz	0	25		25		1472		pF
Reverse transfer capacitance	C_{res}							432		pF
Gate charge	Q_g	$V_{CC} = 960$ V	0/15		600	25		4400		nC

Thermal

Thermal resistance junction to sink ⁽²⁾	$R_{th(j-s)}$	$\lambda_{paste} = 5,2$ W/mK (PTM)						0,13		K/W
--	---------------	---------------------------------------	--	--	--	--	--	------	--	-----

Dynamic

Turn-on delay time	$t_{d(on)}$					25 125 150		448,53 454,88 454,49		ns
Rise time	t_r	$R_{gon} = 2$ Ω $R_{goff} = 2$ Ω				25 125 150		40 41,16 41,75		ns
Turn-off delay time	$t_{d(off)}$		±15	600	600	25 125 150		354,82 392,1 400,56		ns
Fall time	t_f					25 125 150		29,48 49,9 56,18		ns
Turn-on energy (per pulse)	E_{on}	$Q_{tFWD} = 1,2$ μC $Q_{tFWD} = 1,19$ μC $Q_{tFWD} = 1,16$ μC				25 125 150		23,89 24,75 24,23		mWs
Turn-off energy (per pulse)	E_{off}					25 125 150		15,12 24,13 29,41		mWs



Vincotech

30-EP12NIA600H703-PM00F83T
datasheet

Characteristic Values

Parameter	Symbol	Conditions					Values			Unit
		V_{GE} [V] V_{GS} [V]	V_{CE} [V] V_{DS} [V] V_F [V]	I_C [A] I_D [A] I_F [A]	T_j [°C]	Min	Typ	Max		

Buck Diode

Static

Forward voltage	V_F				160	25 125 150		1,49 1,82 1,94	1,65 ⁽¹⁾ 2,3 ⁽¹⁾	V
Reverse leakage current	I_R	$V_r = 1200$ V				25		8	800	μA

Thermal

Thermal resistance junction to sink ⁽²⁾	$R_{th(j-s)}$	$\lambda_{paste} = 5,2$ W/mK (PTM)						0,26		K/W
--	---------------	---------------------------------------	--	--	--	--	--	------	--	-----

Dynamic

Peak recovery current	I_{RM}					25 125 150		126,58 124,27 120,66		A
Reverse recovery time	t_{rr}					25 125 150		16,88 16,78 16,49		ns
Recovered charge	Q_r	$di/dt=17031$ A/μs $di/dt=16259$ A/μs $di/dt=15648$ A/μs	±15	600	600	25 125 150		1,2 1,19 1,16		μC
Reverse recovered energy	E_{rec}					25 125 150		0,136 0,138 0,132		mWs
Peak rate of fall of recovery current	$(di_r/dt)_{max}$					25 125 150		19015,73 24651,94 22411,45		A/μs



Vincotech

30-EP12NIA600H703-PM00F83T
datasheet

Characteristic Values

Parameter	Symbol	Conditions					Values			Unit
		V_{GS} [V]	V_{GE} [V]	V_{DS} [V]	V_F [V]	I_C [A] I_D [A] I_F [A]	T_j [°C]	Min	Typ	

Boost Switch

Static

Gate-emitter threshold voltage	$V_{GE(th)}$			10	0,04	25	5,4	6	6,6	V
Collector-emitter saturation voltage	$V_{CE(sat)}$		15		400	25 125 150		1,74 2,01 2,08	1,85 ⁽¹⁾	V
Collector-emitter cut-off current	I_{CES}		0	1200		25			200	μA
Gate-emitter leakage current	I_{GES}		20	0		25			1000	nA
Internal gate resistance	r_g							1		Ω
Input capacitance	C_{ies}							74000		pF
Output capacitance	C_{oes}		0	10		25		2200		pF
Reverse transfer capacitance	C_{res}							840		pF
Gate charge	Q_g	$V_{CC} = 600$ V	0/15		400	25		2400		nC

Thermal

Thermal resistance junction to sink ⁽²⁾	$R_{th(j-s)}$	$\lambda_{paste} = 5,2$ W/mK (PTM)						0,17		K/W
--	---------------	---------------------------------------	--	--	--	--	--	------	--	-----

Dynamic

Turn-on delay time	$t_{d(on)}$	$R_{gon} = 2$ Ω $R_{goff} = 2$ Ω	±15	600	400	25		428,28		ns				
						125		435,05						
						150		436,05						
Rise time	t_r									25		103,05		ns
										125		115,9		
										150		120,93		
Turn-off delay time	$t_{d(off)}$									25		283,52		ns
						125		320,34						
						150		331,2						
Fall time	t_f					25		67,91		ns				
						125		89,59						
						150		96,53						
Turn-on energy (per pulse)	E_{on}	$Q_{tFWD} = 5,97$ μC $Q_{tFWD} = 13,28$ μC $Q_{tFWD} = 15,74$ μC				25		34,02		mWs				
						125		44,84						
						150		47,91						
Turn-off energy (per pulse)	E_{off}					25		30,36		mWs				
						125		41,66						
						150		44,65						



Vincotech

30-EP12NIA600H703-PM00F83T
datasheet

Characteristic Values

Parameter	Symbol	Conditions					Values			Unit
		V_{GE} [V] V_{GS} [V]	V_{CE} [V] V_{DS} [V] V_F [V]	I_C [A] I_D [A] I_F [A]	T_j [°C]	Min	Typ	Max		
Boost Diode										
Static										
Forward voltage	V_F			200	25 125 150		2,72 2,42 2,34	3 ⁽¹⁾		V
Reverse leakage current	I_R	$V_r = 1200$ V			25			8		μA
Thermal										
Thermal resistance junction to sink ⁽²⁾	$R_{th(j-s)}$	$\lambda_{paste} = 5,2$ W/mK (PTM)					0,48			K/W
Dynamic										
Peak recovery current	I_{RM}	$di/dt=3256$ A/μs $di/dt=3499$ A/μs $di/dt=2911$ A/μs	±15	600	400	25		96,99		A
Reverse recovery time	t_{rr}					125		113,85		
						150		119,02		
						25		157,94		
Recovered charge	Q_r					125		255,7		
						150		291,62		
		25		5,97						
Reverse recovered energy	E_{rec}	125		13,28						
		150		15,74						
		25		1,45						
Peak rate of fall of recovery current	$(di_r/dt)_{max}$	125		3,55						
		150		4,3						
		25		3387,9						
						125		943,29		A/μs
						150		472,79		



Vincotech

Characteristic Values

Parameter	Symbol	Conditions					Values			Unit
		V_{GE} [V] V_{GS} [V]	V_{CE} [V] V_{DS} [V] V_F [V]	I_C [A] I_D [A] I_F [A]	T_j [°C]	Min	Typ	Max		

Boost Sw. Inv. Diode

Static

Forward voltage	V_F				200	25 125 150		2,72 2,42 2,34	3 ⁽¹⁾	V
Reverse leakage current	I_R	$V_r = 1200$ V				25			8	μA

Thermal

Thermal resistance junction to sink ⁽²⁾	$R_{th(j-s)}$	$\lambda_{paste} = 5,2$ W/mK (PTM)						0,48		K/W
--	---------------	---------------------------------------	--	--	--	--	--	------	--	-----

Thermistor

Static

Rated resistance	R					25		22		kΩ
Deviation of R100	$\Delta_{R/R}$	$R_{100} = 1484$ Ω				100	-5		5	%
Power dissipation	P					25		130		mW
Power dissipation constant	d					25		1,5		mW/K
B-value	$B_{(25/50)}$	Tol. ±1 %						3962		K
B-value	$B_{(25/100)}$	Tol. ±1 %						4000		K
Vincotech Thermistor Reference									I	

⁽¹⁾ Value at chip level

⁽²⁾ Only valid with pre-applied Vincotech thermal interface material.



Buck Switch Characteristics

figure 1. IGBT

Typical output characteristics

$$I_c = f(V_{CE})$$

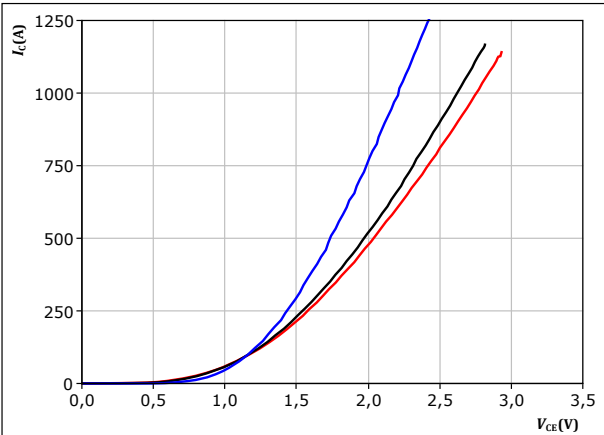

$t_p = 250 \mu\text{s}$
 $V_{GE} = 15 \text{ V}$
 $T_j:$ — 25°C
— 125°C
— 150°C

figure 2. IGBT

Typical output characteristics

$$I_c = f(V_{CE})$$

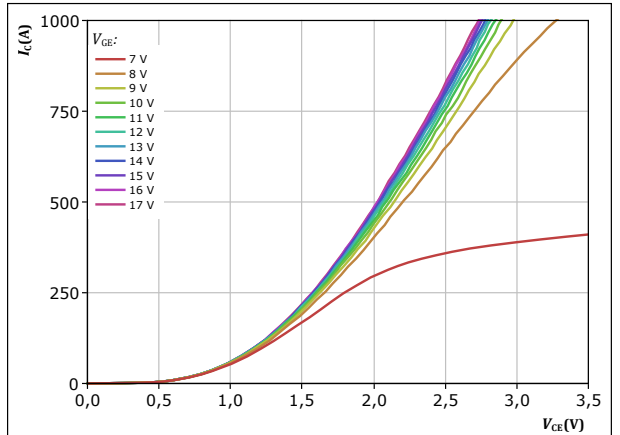

$t_p = 250 \mu\text{s}$
 $T_j = 150^\circ\text{C}$
 V_{GE} from 7 V to 17 V in steps of 1 V

figure 3. IGBT

Typical transfer characteristics

$$I_c = f(V_{GE})$$

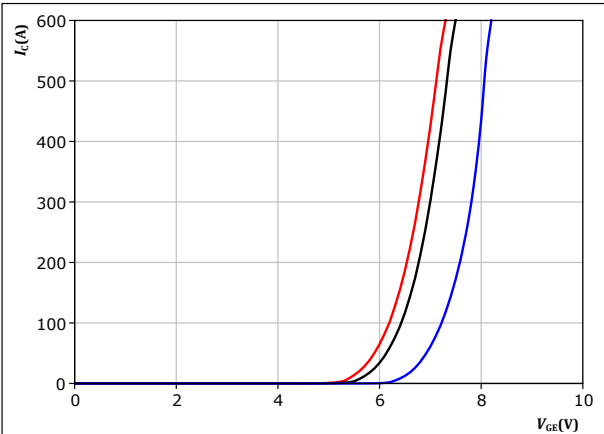

$t_p = 250 \mu\text{s}$
 $V_{CE} = 10 \text{ V}$
 $T_j:$ — 25°C
— 125°C
— 150°C

figure 4. IGBT

Transient thermal impedance as a function of pulse width

$$Z_{th(j-s)} = f(t_p)$$

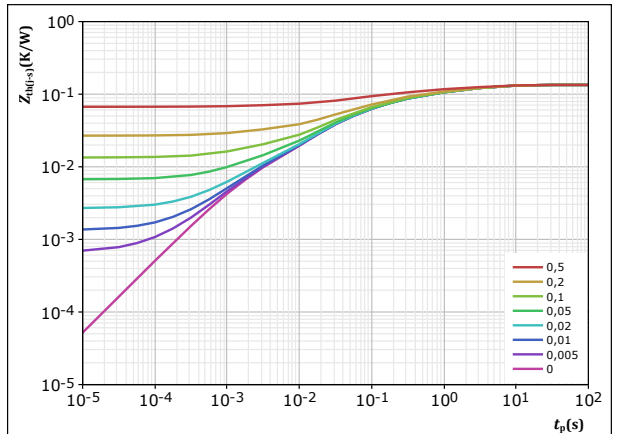

$D = t_p / T$
 $R_{th(j-s)} = 0,134 \text{ K/W}$
IGBT thermal model values

R (K/W)	τ (s)
1,79E-02	5,14E+00
2,60E-02	1,43E+00
4,74E-02	1,95E-01
3,68E-02	2,86E-02
6,13E-03	1,70E-03



Buck Switch Characteristics

figure 5. IGBT

Gate voltage vs gate charge

$$V_{GE} = f(Q_g)$$

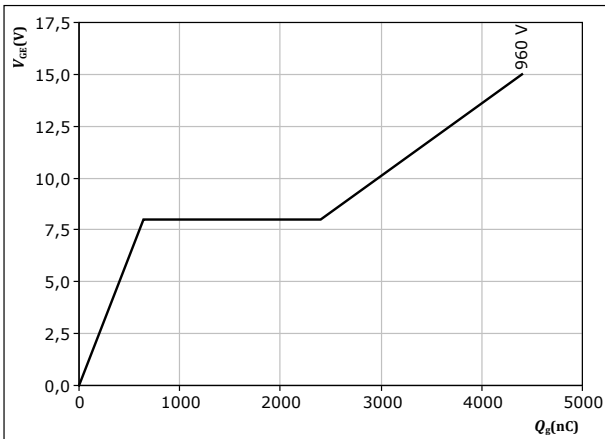

$I_c = 600$ A
 $T_j = 25$ °C



Buck Diode Characteristics

figure 6. FWD

Typical forward characteristics

$$I_F = f(V_F)$$

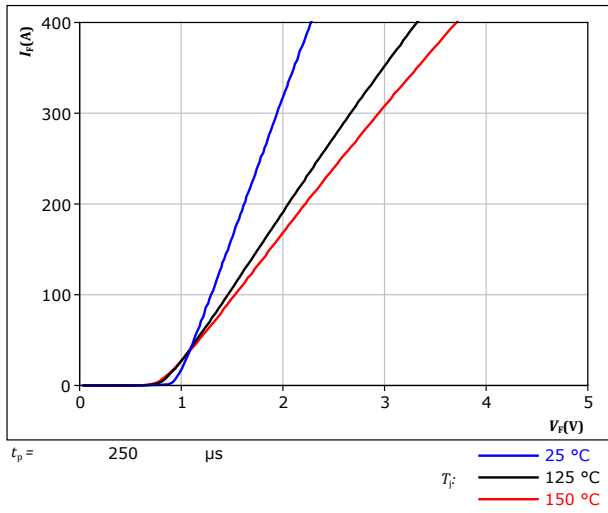
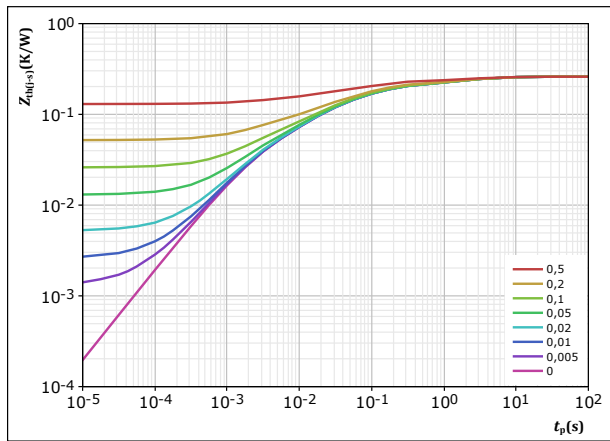

figure 7. FWD

Transient thermal impedance as a function of pulse width

$$Z_{th(j-s)} = f(t_p)$$



$D =$	t_p / T	
$R_{th(j-s)} =$	0,26	K/W
FWD thermal model values		
R (K/W)	τ (s)	
2,45E-02	4,55E+00	
3,89E-02	1,09E+00	
1,02E-01	8,48E-02	
6,60E-02	1,47E-02	
2,83E-02	2,05E-03	



Boost Switch Characteristics

figure 8. IGBT

Typical output characteristics
 $I_C = f(V_{CE})$

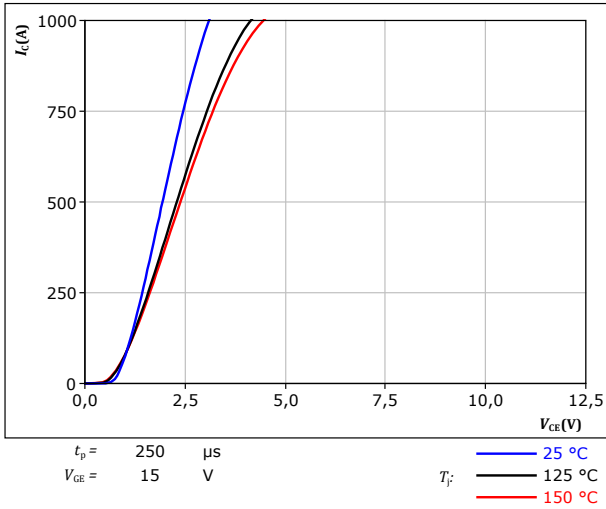

figure 9. IGBT

Typical output characteristics
 $I_C = f(V_{CE})$

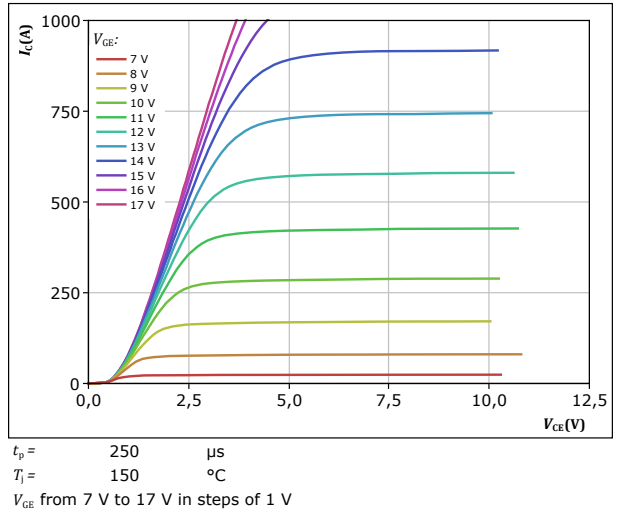

figure 10. IGBT

Typical transfer characteristics
 $I_C = f(V_{GE})$

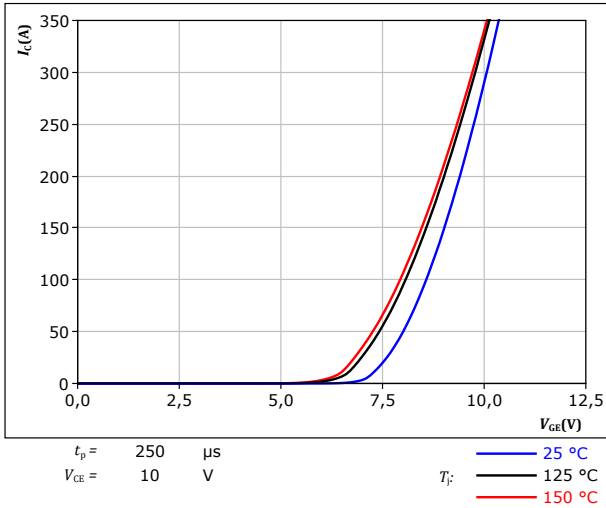
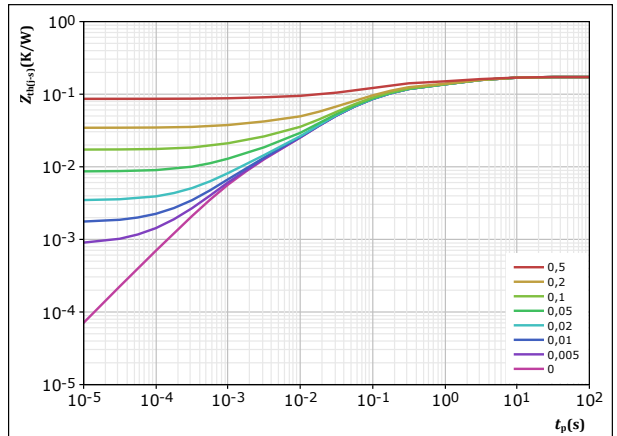

figure 11. IGBT

Transient thermal impedance as a function of pulse width
 $Z_{th(j-s)} = f(t_p)$



$D = t_p / T$
 $R_{th(j-s)} = 0,172 \text{ K/W}$

IGBT thermal model values

R (K/W)	τ (s)
2,18E-02	5,31E+00
3,84E-02	1,27E+00
7,42E-02	1,08E-01
3,10E-02	2,16E-02
6,97E-03	1,39E-03



Boost Switch Characteristics

figure 12. IGBT

Safe operating area
 $I_C = f(V_{CE})$

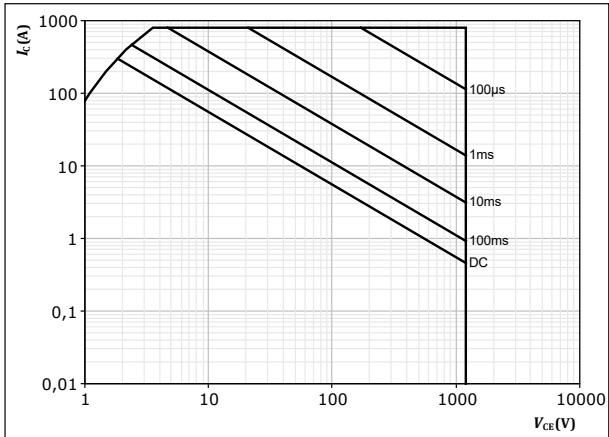

$D =$ single pulse
 $T_s = 80$ °C
 $V_{GE} = 15$ V
 $T_j = T_{jmax}$

figure 13. IGBT

Gate voltage vs gate charge
 $V_{GE} = f(Q_g)$

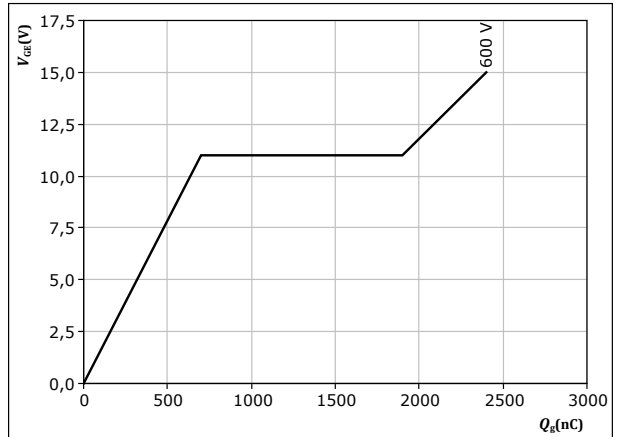

$I_C = 400$ A
 $T_j = 25$ °C



Boost Diode Characteristics

figure 14. FWD

Typical forward characteristics

$$I_F = f(V_F)$$

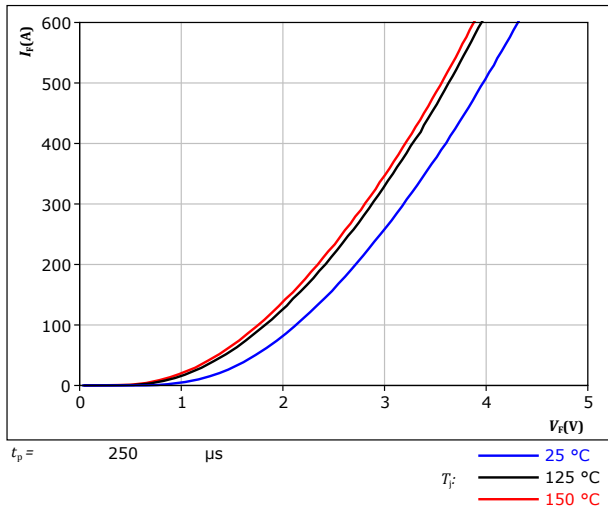
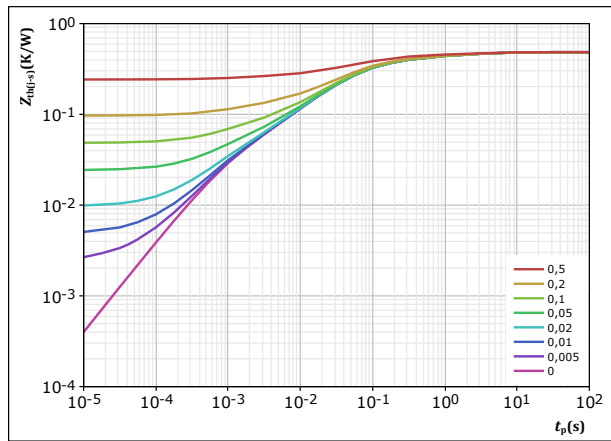

figure 15. FWD

Transient thermal impedance as a function of pulse width

$$Z_{th(j-s)} = f(t_p)$$



$D = t_p / T$
 $R_{th(j-s)} = 0,484 \text{ K/W}$
 FWD thermal model values

R (K/W)	τ (s)
4,96E-02	3,28E+00
7,95E-02	4,30E-01
2,38E-01	6,16E-02
8,86E-02	1,21E-02
2,86E-02	9,94E-04



Boost Sw. Inv. Diode Characteristics

figure 16. FWD

Typical forward characteristics

$$I_F = f(V_F)$$

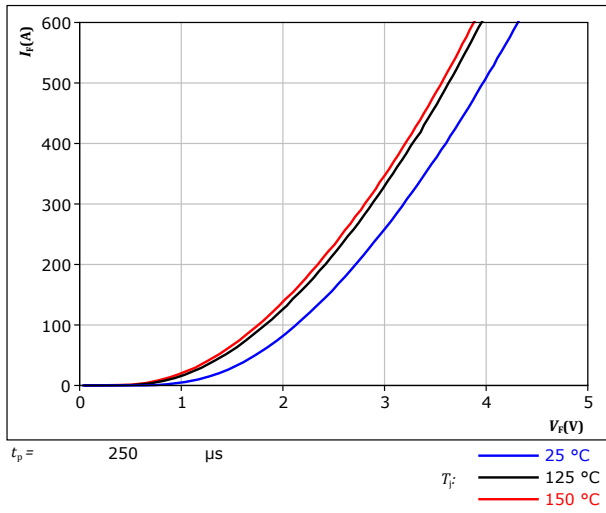
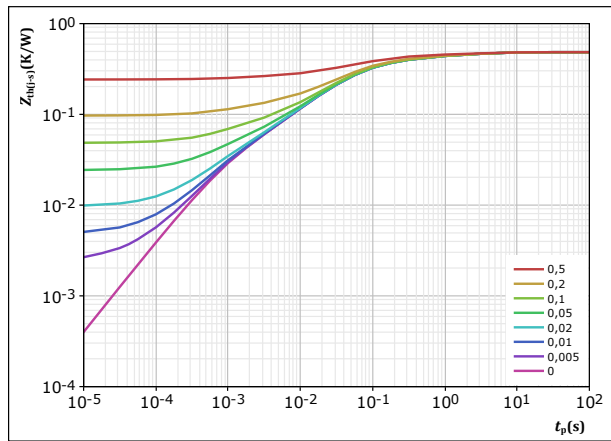

figure 17. FWD

Transient thermal impedance as a function of pulse width

$$Z_{th(j-s)} = f(t_p)$$



$D = \frac{t_p}{T}$
 $R_{th(j-s)} = 0,484 \text{ K/W}$
 FWD thermal model values

R (K/W)	τ (s)
4,96E-02	3,28E+00
7,95E-02	4,30E-01
2,38E-01	6,16E-02
8,86E-02	1,21E-02
2,86E-02	9,94E-04



Thermistor Characteristics

figure 18. Thermistor

Typical NTC characteristic as function of temperature

$$R_T = f(T)$$

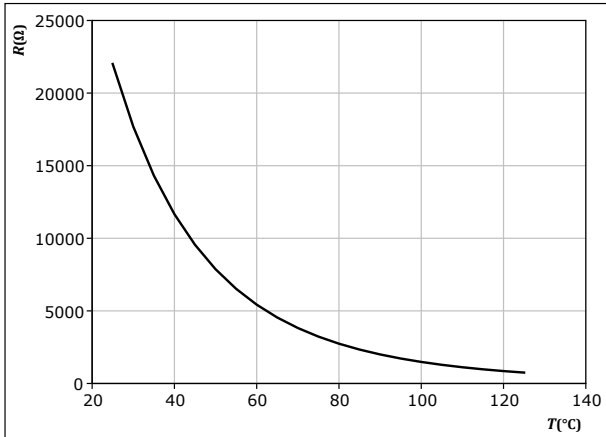



Buck Switching Characteristics

figure 19. IGBT

Typical switching energy losses as a function of collector current
 $E = f(I_c)$

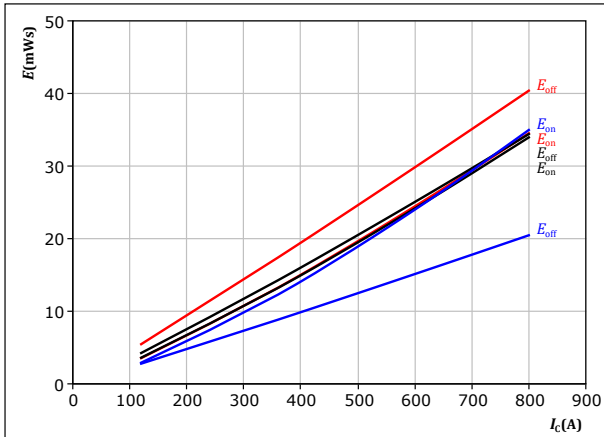

With an inductive load at

$V_{CE} = 600 \text{ V}$
 $V_{GE} = \pm 15 \text{ V}$
 $R_{gon} = 2 \ \Omega$
 $R_{goff} = 2 \ \Omega$

T_j : — 25 °C
 — 125 °C
 — 150 °C

figure 20. IGBT

Typical switching energy losses as a function of IGBT turn on gate resistor
 $E = f(R_g)$

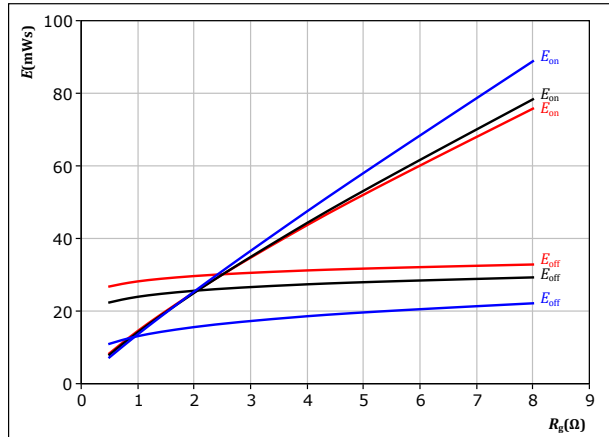

With an inductive load at

$V_{CE} = 600 \text{ V}$
 $V_{GE} = \pm 15 \text{ V}$
 $I_c = 600 \text{ A}$

T_j : — 25 °C
 — 125 °C
 — 150 °C

figure 21. FWD

Typical reverse recovered energy loss as a function of collector current
 $E_{rec} = f(I_c)$

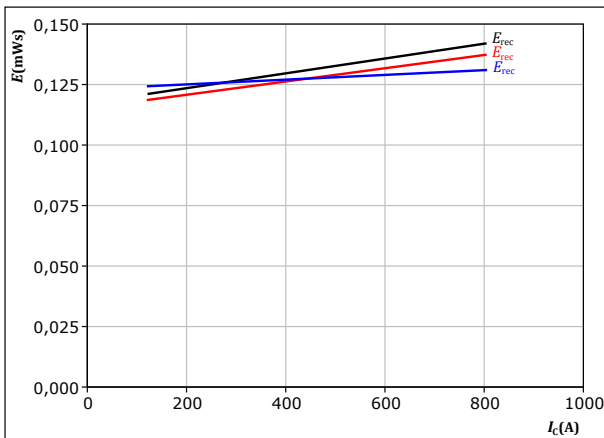

With an inductive load at

$V_{CE} = 600 \text{ V}$
 $V_{GE} = \pm 15 \text{ V}$
 $R_{gon} = 2 \ \Omega$

T_j : — 25 °C
 — 125 °C
 — 150 °C

figure 22. FWD

Typical reverse recovered energy loss as a function of IGBT turn on gate resistor
 $E_{rec} = f(R_g)$

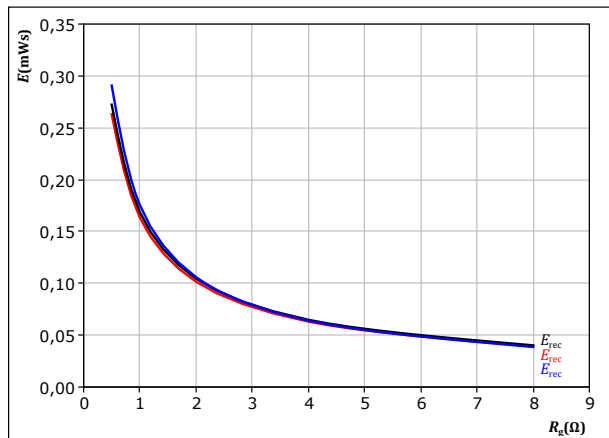

With an inductive load at

$V_{CE} = 600 \text{ V}$
 $V_{GE} = \pm 15 \text{ V}$
 $I_c = 600 \text{ A}$

T_j : — 25 °C
 — 125 °C
 — 150 °C



Buck Switching Characteristics

figure 23. IGBT

Typical switching times as a function of collector current
 $t = f(I_c)$

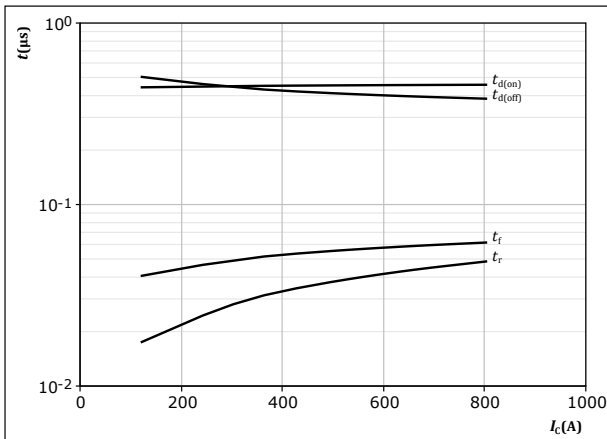

With an inductive load at
 $T_j = 150 \text{ }^\circ\text{C}$
 $V_{CE} = 600 \text{ V}$
 $V_{GE} = \pm 15 \text{ V}$
 $R_{gon} = 2 \text{ } \Omega$
 $R_{goff} = 2 \text{ } \Omega$

figure 24. IGBT

Typical switching times as a function of IGBT turn on gate resistor
 $t = f(R_g)$

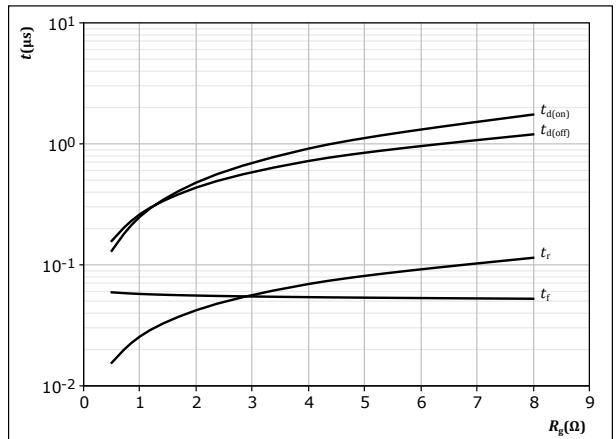

With an inductive load at
 $T_j = 150 \text{ }^\circ\text{C}$
 $V_{CE} = 600 \text{ V}$
 $V_{GE} = \pm 15 \text{ V}$
 $I_c = 600 \text{ A}$

figure 25. FWD

Typical reverse recovery time as a function of collector current
 $t_{rr} = f(I_c)$

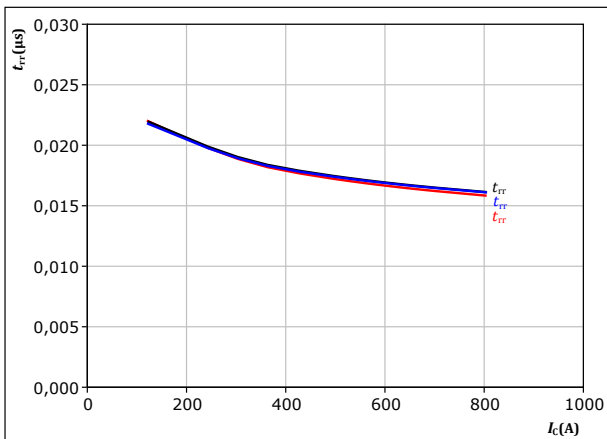

With an inductive load at
 $V_{CE} = 600 \text{ V}$
 $V_{GE} = \pm 15 \text{ V}$
 $R_{gon} = 2 \text{ } \Omega$
 $T_j:$ — 25 $^\circ\text{C}$
 — 125 $^\circ\text{C}$
 — 150 $^\circ\text{C}$

figure 26. FWD

Typical reverse recovery time as a function of IGBT turn on gate resistor
 $t_{rr} = f(R_{gon})$

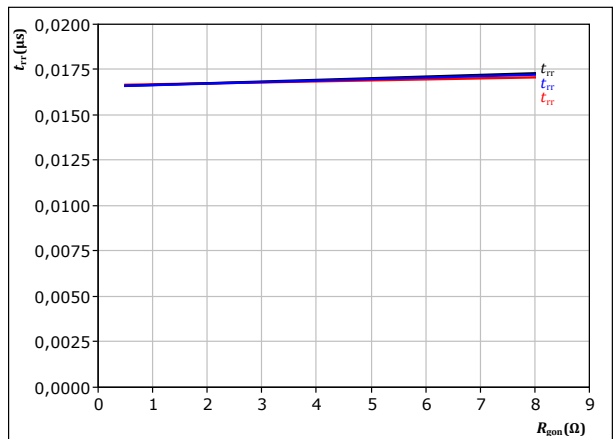

With an inductive load at
 $V_{CE} = 600 \text{ V}$
 $V_{GE} = \pm 15 \text{ V}$
 $I_c = 600 \text{ A}$
 $T_j:$ — 25 $^\circ\text{C}$
 — 125 $^\circ\text{C}$
 — 150 $^\circ\text{C}$



Buck Switching Characteristics

figure 27. FWD

Typical recovered charge as a function of collector current

$$Q_r = f(I_c)$$

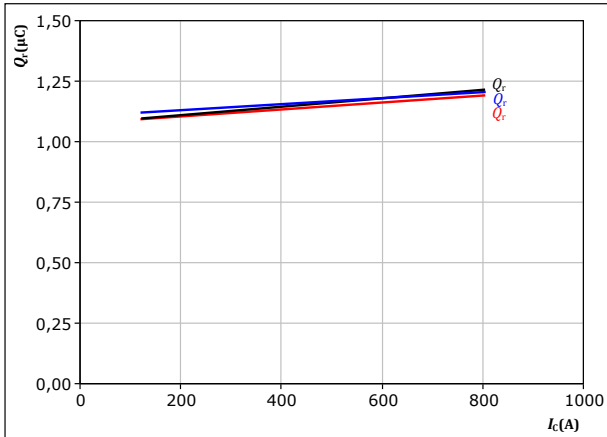

With an inductive load at

$V_{CE} = 600 \text{ V}$
 $V_{GE} = \pm 15 \text{ V}$
 $R_{gon} = 2 \ \Omega$

T_j : — 25 °C
— 125 °C
— 150 °C

figure 28. FWD

Typical recovered charge as a function of IGBT turn on gate resistor

$$Q_r = f(R_{gon})$$



With an inductive load at

$V_{CE} = 600 \text{ V}$
 $V_{GE} = \pm 15 \text{ V}$
 $I_c = 600 \text{ A}$

T_j : — 25 °C
— 125 °C
— 150 °C

figure 29. FWD

Typical peak reverse recovery current as a function of collector current

$$I_{RM} = f(I_c)$$

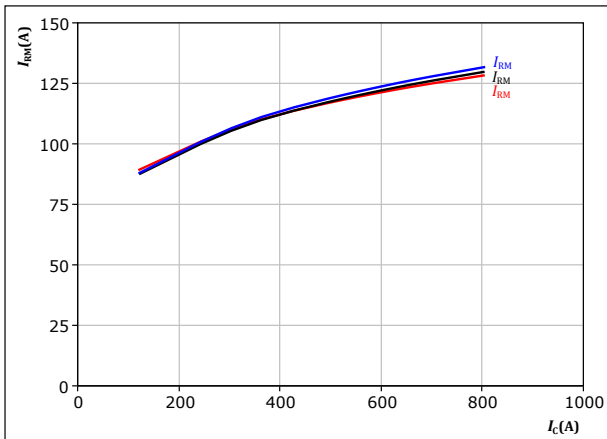

With an inductive load at

$V_{CE} = 600 \text{ V}$
 $V_{GE} = \pm 15 \text{ V}$
 $R_{gon} = 2 \ \Omega$

T_j : — 25 °C
— 125 °C
— 150 °C

figure 30. FWD

Typical peak reverse recovery current as a function of IGBT turn on gate resistor

$$I_{RM} = f(R_{gon})$$

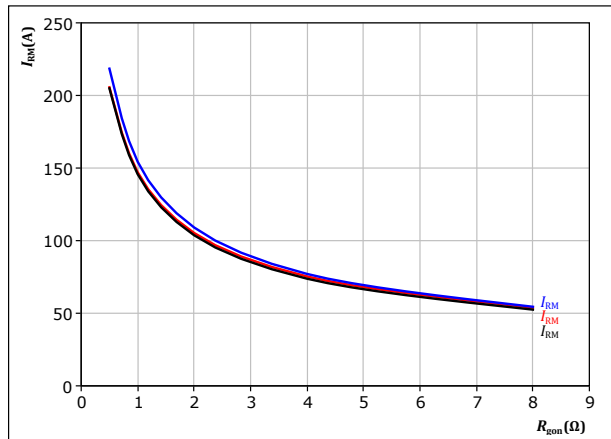

With an inductive load at

$V_{CE} = 600 \text{ V}$
 $V_{GE} = \pm 15 \text{ V}$
 $I_c = 600 \text{ A}$

T_j : — 25 °C
— 125 °C
— 150 °C



Buck Switching Characteristics

figure 31. FWD

Typical rate of fall of forward and reverse recovery current as a function of collector current
 $di_f/dt, di_r/dt = f(I_c)$

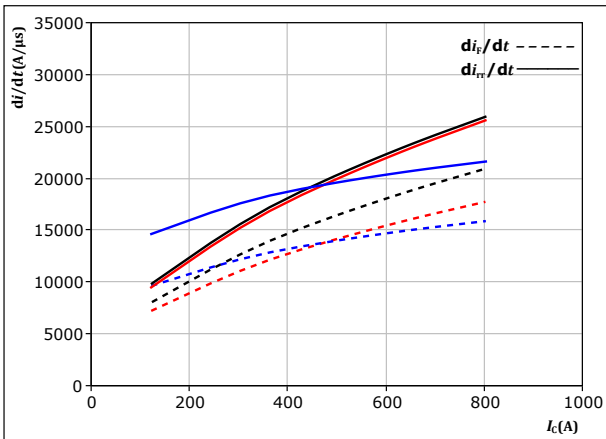

With an inductive load at

$V_{CE} = 600 \text{ V}$
 $V_{GE} = \pm 15 \text{ V}$
 $R_{gon} = 2 \ \Omega$

T_j :
— 25 °C
— 125 °C
— 150 °C

figure 32. FWD

Typical rate of fall of forward and reverse recovery current as a function of turn on gate resistor
 $di_f/dt, di_r/dt = f(R_{gon})$

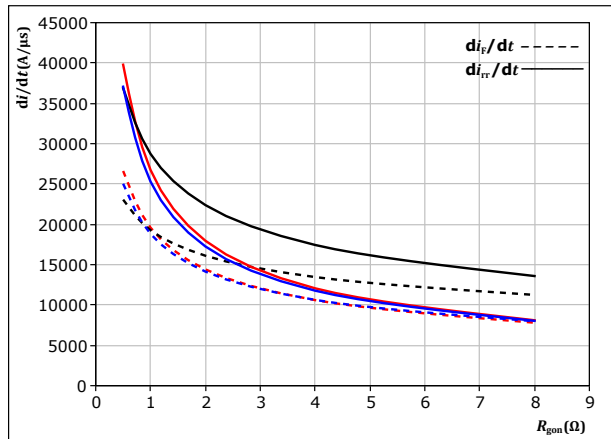

With an inductive load at

$V_{CE} = 600 \text{ V}$
 $V_{GE} = \pm 15 \text{ V}$
 $I_c = 600 \text{ A}$

T_j :
— 25 °C
— 125 °C
— 150 °C

figure 33. IGBT

Reverse bias safe operating area

$I_c = f(V_{CE})$

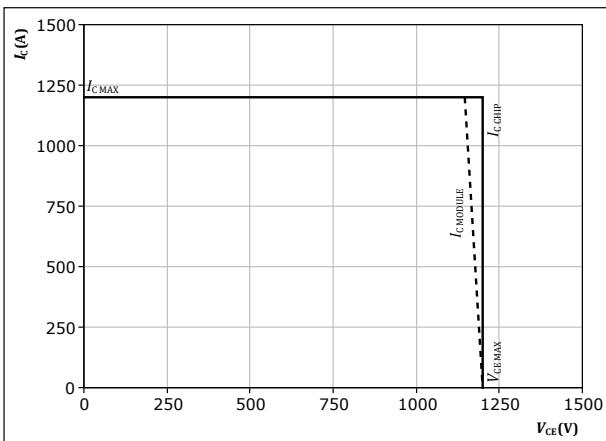

At $T_j = 150 \text{ °C}$
 $R_{gon} = 2 \ \Omega$
 $R_{goff} = 2 \ \Omega$



Boost Switching Characteristics

figure 34. IGBT

Typical switching energy losses as a function of collector current
 $E = f(I_c)$

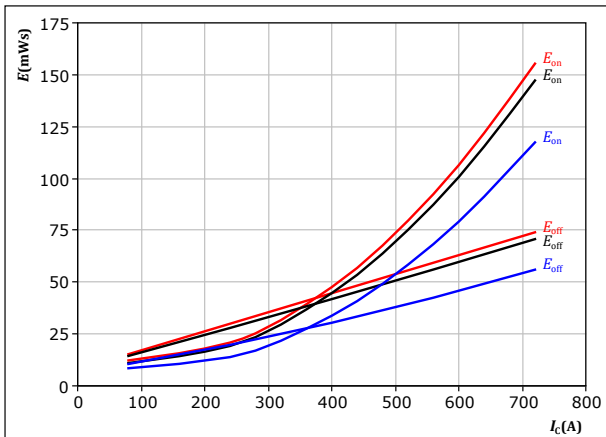

With an inductive load at

$V_{CE} = 600 \text{ V}$
 $V_{GE} = \pm 15 \text{ V}$
 $R_{gon} = 2 \text{ } \Omega$
 $R_{goff} = 2 \text{ } \Omega$

T_j : — 25 °C
 — 125 °C
 — 150 °C

figure 35. IGBT

Typical switching energy losses as a function of IGBT turn on gate resistor
 $E = f(R_g)$

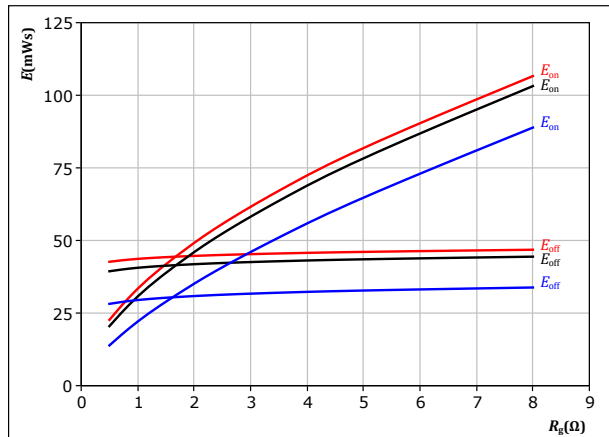

With an inductive load at

$V_{CE} = 600 \text{ V}$
 $V_{GE} = \pm 15 \text{ V}$
 $I_c = 400 \text{ A}$

T_j : — 25 °C
 — 125 °C
 — 150 °C

figure 36. FWD

Typical reverse recovered energy loss as a function of collector current
 $E_{rec} = f(I_c)$

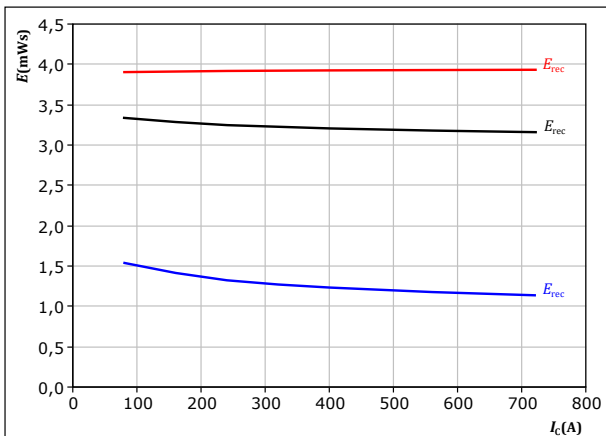

With an inductive load at

$V_{CE} = 600 \text{ V}$
 $V_{GE} = \pm 15 \text{ V}$
 $R_{gon} = 2 \text{ } \Omega$

T_j : — 25 °C
 — 125 °C
 — 150 °C

figure 37. FWD

Typical reverse recovered energy loss as a function of IGBT turn on gate resistor
 $E_{rec} = f(R_g)$

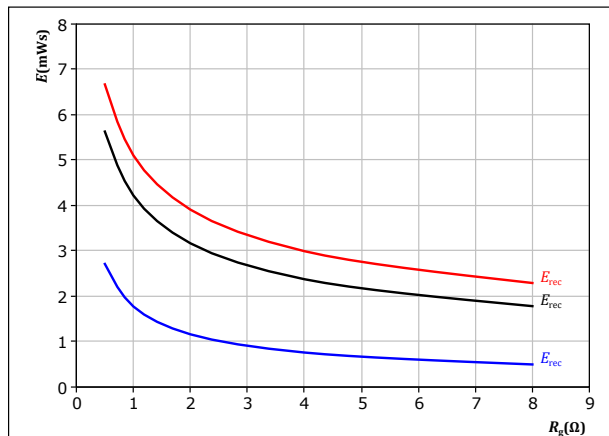

With an inductive load at

$V_{CE} = 600 \text{ V}$
 $V_{GE} = \pm 15 \text{ V}$
 $I_c = 400 \text{ A}$

T_j : — 25 °C
 — 125 °C
 — 150 °C



Boost Switching Characteristics

figure 38. IGBT

Typical switching times as a function of collector current
 $t = f(I_c)$

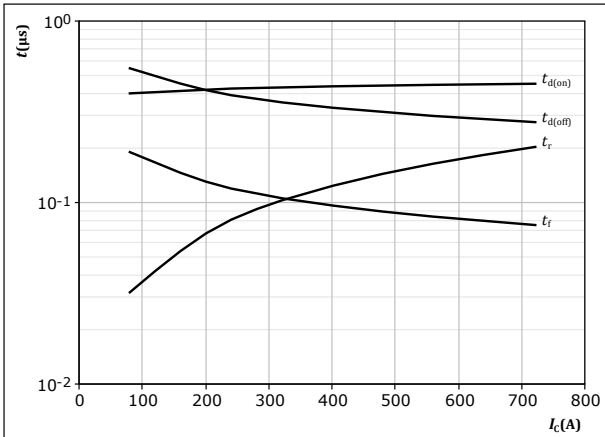

With an inductive load at
 $T_j = 150 \text{ }^\circ\text{C}$
 $V_{CE} = 600 \text{ V}$
 $V_{GE} = \pm 15 \text{ V}$
 $R_{gon} = 2 \text{ } \Omega$
 $R_{goff} = 2 \text{ } \Omega$

figure 39. IGBT

Typical switching times as a function of IGBT turn on gate resistor
 $t = f(R_g)$

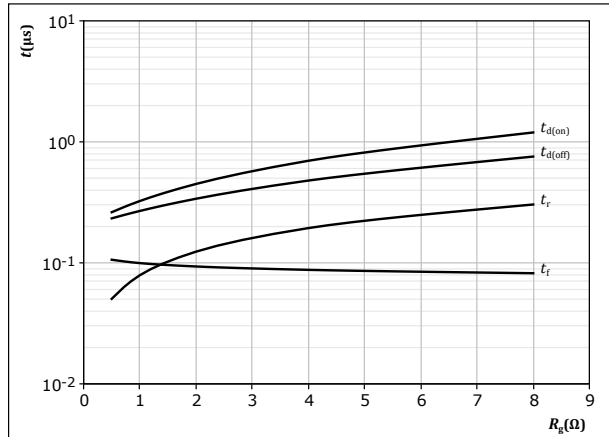

With an inductive load at
 $T_j = 150 \text{ }^\circ\text{C}$
 $V_{CE} = 600 \text{ V}$
 $V_{GE} = \pm 15 \text{ V}$
 $I_c = 400 \text{ A}$

figure 40. FWD

Typical reverse recovery time as a function of collector current
 $t_{rr} = f(I_c)$

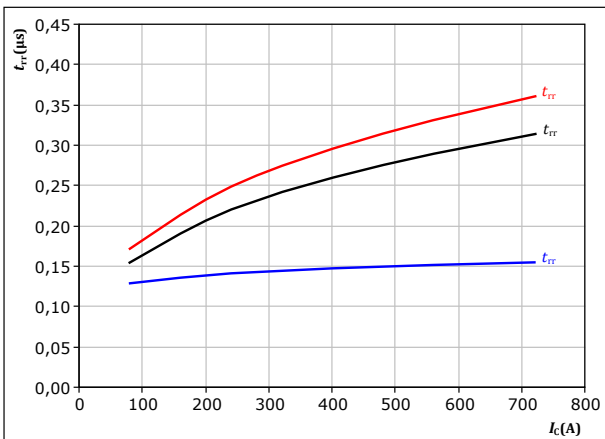

With an inductive load at
 $V_{CE} = 600 \text{ V}$
 $V_{GE} = \pm 15 \text{ V}$
 $R_{gon} = 2 \text{ } \Omega$
 $T_j:$ — 25 °C
— 125 °C
— 150 °C

figure 41. FWD

Typical reverse recovery time as a function of IGBT turn on gate resistor
 $t_{rr} = f(R_{gon})$

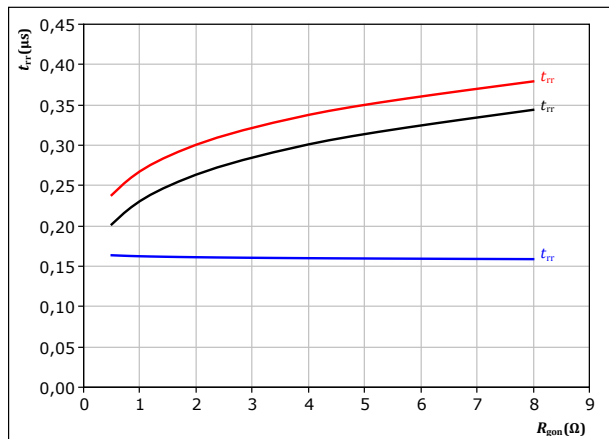

With an inductive load at
 $V_{CE} = 600 \text{ V}$
 $V_{GE} = \pm 15 \text{ V}$
 $I_c = 400 \text{ A}$
 $T_j:$ — 25 °C
— 125 °C
— 150 °C



Boost Switching Characteristics

figure 42. FWD

Typical recovered charge as a function of collector current

$$Q_r = f(I_c)$$

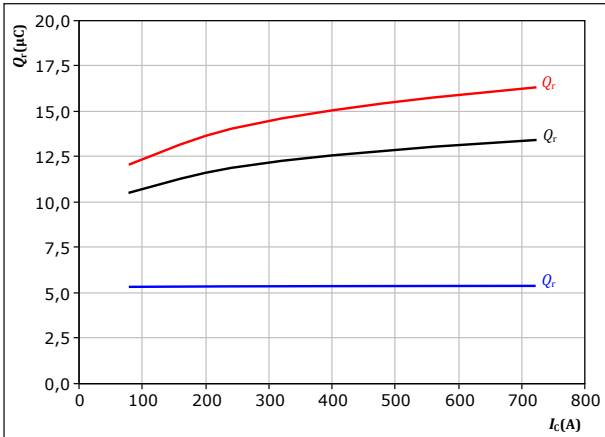

With an inductive load at

$V_{CE} =$	600	V	$T_j:$	25 °C
$V_{GE} =$	±15	V		125 °C
$R_{gon} =$	2	Ω		150 °C

figure 44. FWD

Typical peak reverse recovery current as a function of collector current

$$I_{RM} = f(I_c)$$

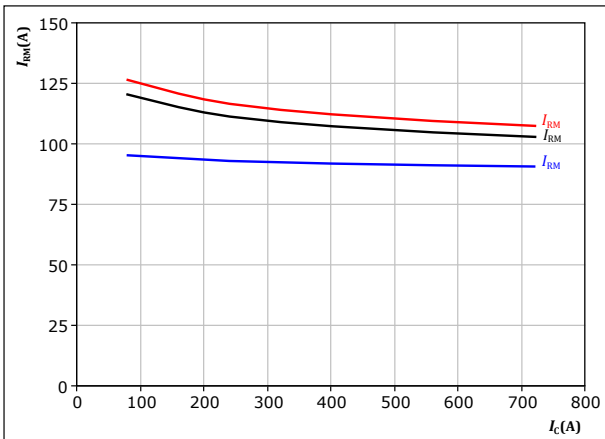

With an inductive load at

$V_{CE} =$	600	V	$T_j:$	25 °C
$V_{GE} =$	±15	V		125 °C
$R_{gon} =$	2	Ω		150 °C

figure 43. FWD

Typical recovered charge as a function of IGBT turn on gate resistor

$$Q_r = f(R_{gon})$$

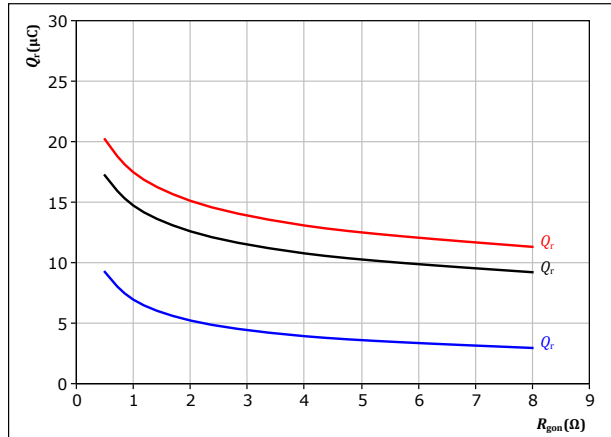

With an inductive load at

$V_{CE} =$	600	V	$T_j:$	25 °C
$V_{GE} =$	±15	V		125 °C
$I_c =$	400	A		150 °C

figure 45. FWD

Typical peak reverse recovery current as a function of IGBT turn on gate resistor

$$I_{RM} = f(R_{gon})$$

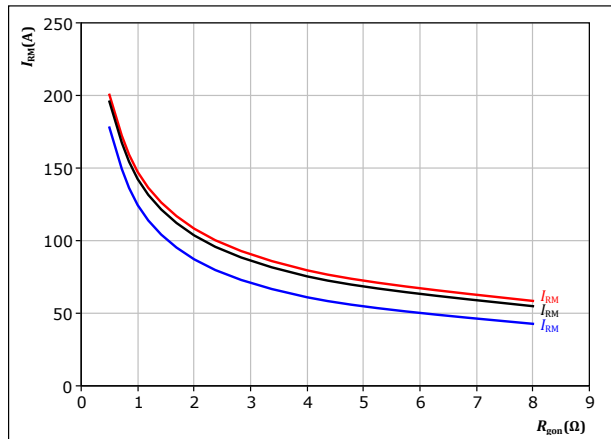

With an inductive load at

$V_{CE} =$	600	V	$T_j:$	25 °C
$V_{GE} =$	±15	V		125 °C
$I_c =$	400	A		150 °C



Boost Switching Characteristics

figure 46. FWD

Typical rate of fall of forward and reverse recovery current as a function of collector current
 $di_f/dt, di_r/dt = f(I_c)$

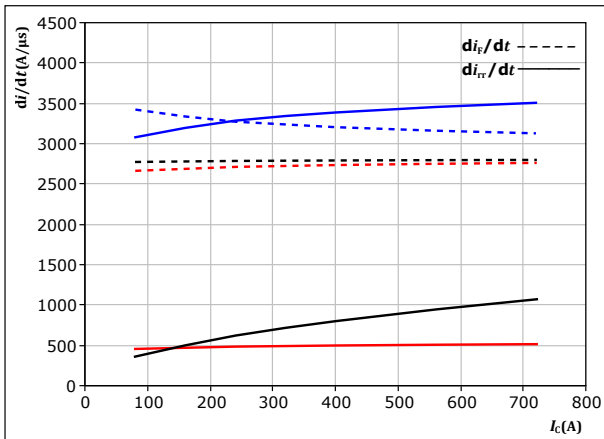

With an inductive load at

$V_{CE} = 600 \text{ V}$
 $V_{GE} = \pm 15 \text{ V}$
 $R_{gon} = 2 \text{ } \Omega$

$T_f:$
— 25 °C
— 125 °C
— 150 °C

figure 47. FWD

Typical rate of fall of forward and reverse recovery current as a function of turn on gate resistor
 $di_f/dt, di_r/dt = f(R_{gon})$

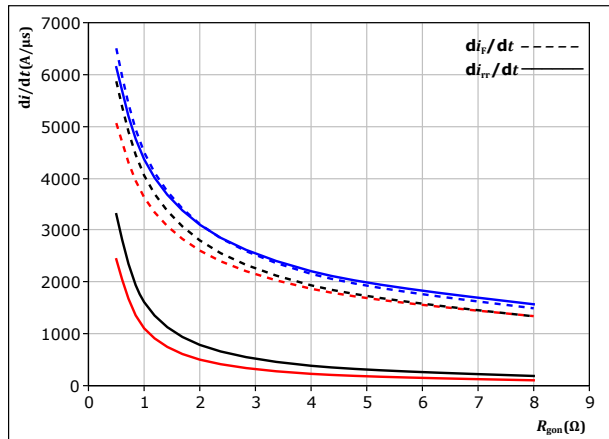

With an inductive load at

$V_{CE} = 600 \text{ V}$
 $V_{GE} = \pm 15 \text{ V}$
 $I_c = 400 \text{ A}$

$T_f:$
— 25 °C
— 125 °C
— 150 °C

figure 48. IGBT

Reverse bias safe operating area

$I_c = f(V_{CE})$

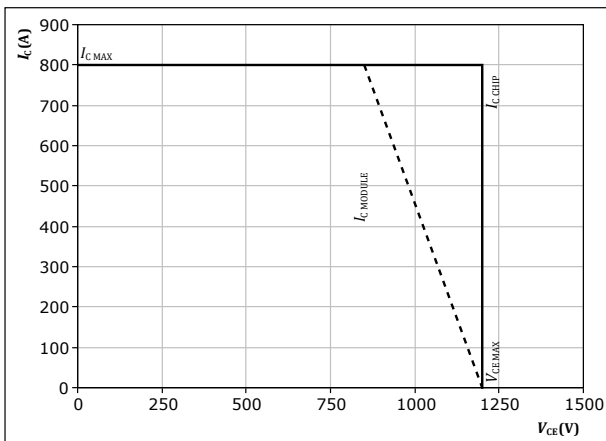

At $T_f = 150 \text{ } ^\circ\text{C}$
 $R_{gon} = 2 \text{ } \Omega$
 $R_{goff} = 2 \text{ } \Omega$



Switching Definitions

figure 49. IGBT

Turn-off Switching Waveforms & definition of t_{doff} , t_{Eoff} (t_{Eoff} = integrating time for E_{off})

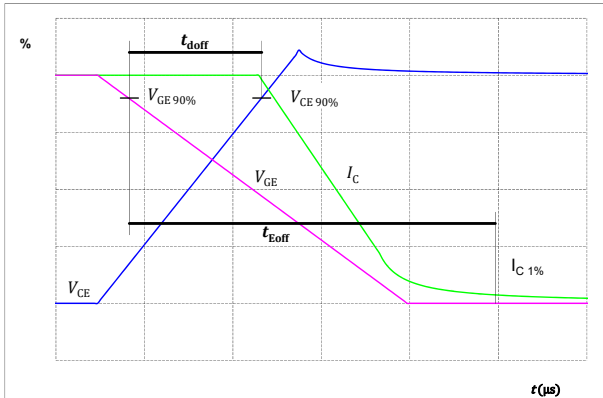

figure 50. IGBT

Turn-on Switching Waveforms & definition of t_{don} , t_{Eon} (t_{Eon} = integrating time for E_{on})

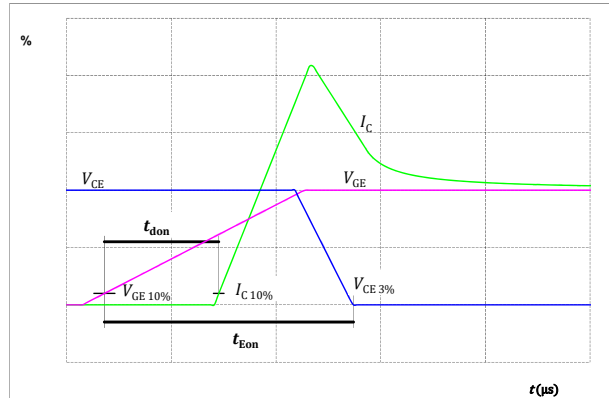

figure 51. IGBT

Turn-off Switching Waveforms & definition of t_f

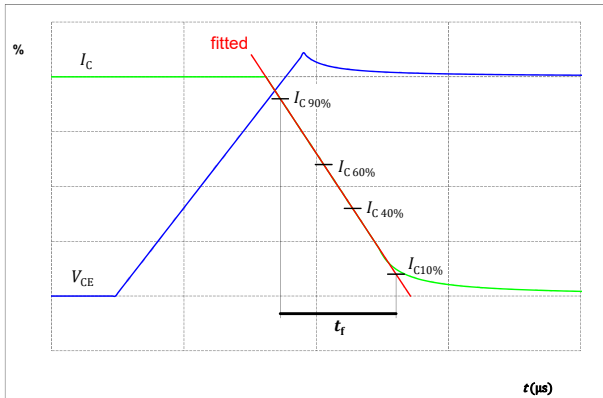
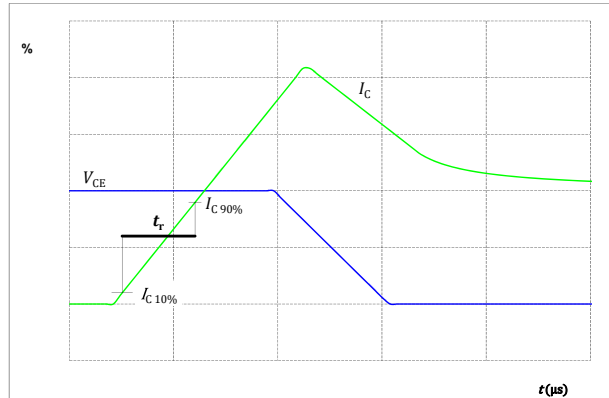

figure 52. IGBT

Turn-on Switching Waveforms & definition of t_r





Switching Definitions

figure 53. FWD

Turn-off Switching Waveforms & definition of t_{rr}

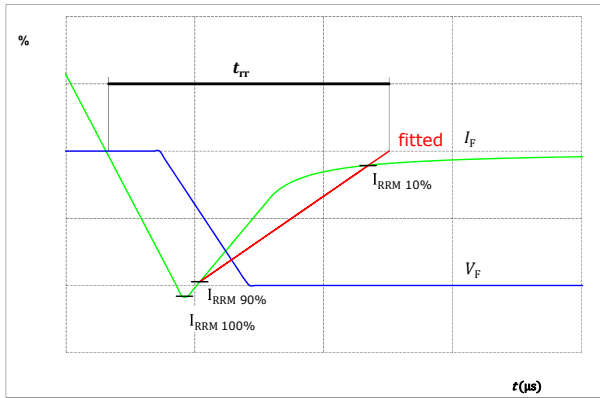
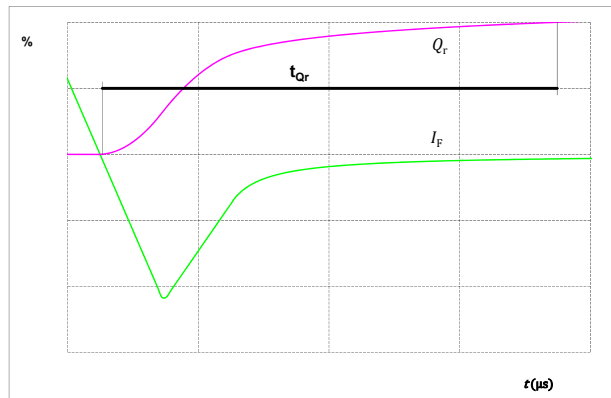

figure 54. FWD

Turn-on Switching Waveforms & definition of t_{Qr} (t_{Qr} = integrating time for Q_r)





Vincotech

30-EP12NIA600H703-PM00F83T
datasheet

Ordering Code	
Version	Ordering Code
Without thermal paste	30-EP12NIA600H703-PM00F83T
With thermal paste (5,2 W/mK, PTM6000HV)	30-EP12NIA600H703-PM00F83T-/7/

Marking						
	Text	Name NN-NNNNNNNNNNNNNNNNNN- TTTTIVV	Date code WWYY	UL & VIN UL VIN	Lot LLLLL	Serial SSSS
	Datamatrix	Type&Ver TTTTIVV	Lot number LLLLL	Serial SSSS	Date code WWYY	

Outline							
Pin table [mm]							
Pin	X	Y	Function	29	22,4	48	Ph12
1	52,96	0	DC-	30	25,6	48	Ph12
2	56,16	0	DC-	31	40,16	48	Ph11
3	59,36	0	DC-	32	43,36	48	Ph11
4	56,16	3,2	DC-	33	46,56	48	Ph11
5	56,16	6,4	DC-	34	49,76	48	Ph11
6	56,16	9,6	DC-	35	52,96	48	Ph11
7	0	0	GND21	36	56,16	48	Ph11
8	3,2	0	GND21	37	6,4	32	G11-1
9	6,4	0	GND21	38	25,6	32	G11-2
10	25,6	0	GND22	39	3,2	32	S11
11	28,8	0	GND22	40	9,6	32	S11
12	32	0	GND22	41	22,4	32	S11
13	40,16	0	GND12	42	28,8	32	S11
14	43,36	0	GND12	43	56,16	22,4	G12
15	46,56	0	GND12	44	52,96	22,4	S12
16	65,76	0	GND11	45	59,36	22,4	S12
17	68,96	0	GND11	46	16	44,8	S13
18	72,16	0	GND11	47	12,8	44,8	G13-1
19	12,8	0	DC+	48	19,2	44,8	G13-2
20	16	0	DC+	49	56,16	35,2	S14
21	19,2	0	DC+	50	52,96	35,2	G14-2
22	16	3,2	DC+	51	59,36	35,2	G14-1
23	16	6,4	DC+	52	65,76	48	Therm1
24	16	9,6	DC+	53	72,16	48	Therm2
25	9,6	48	Ph12	54	32	32	P
26	12,8	48	Ph12	55	56,16	32	N
27	16	48	Ph12				
28	19,2	48	Ph12				

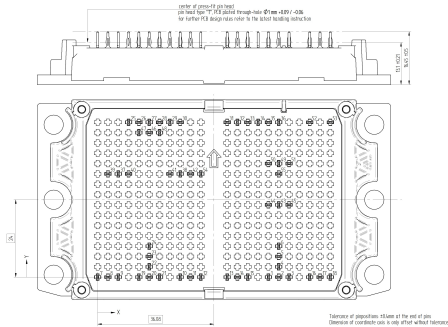



Vincotech

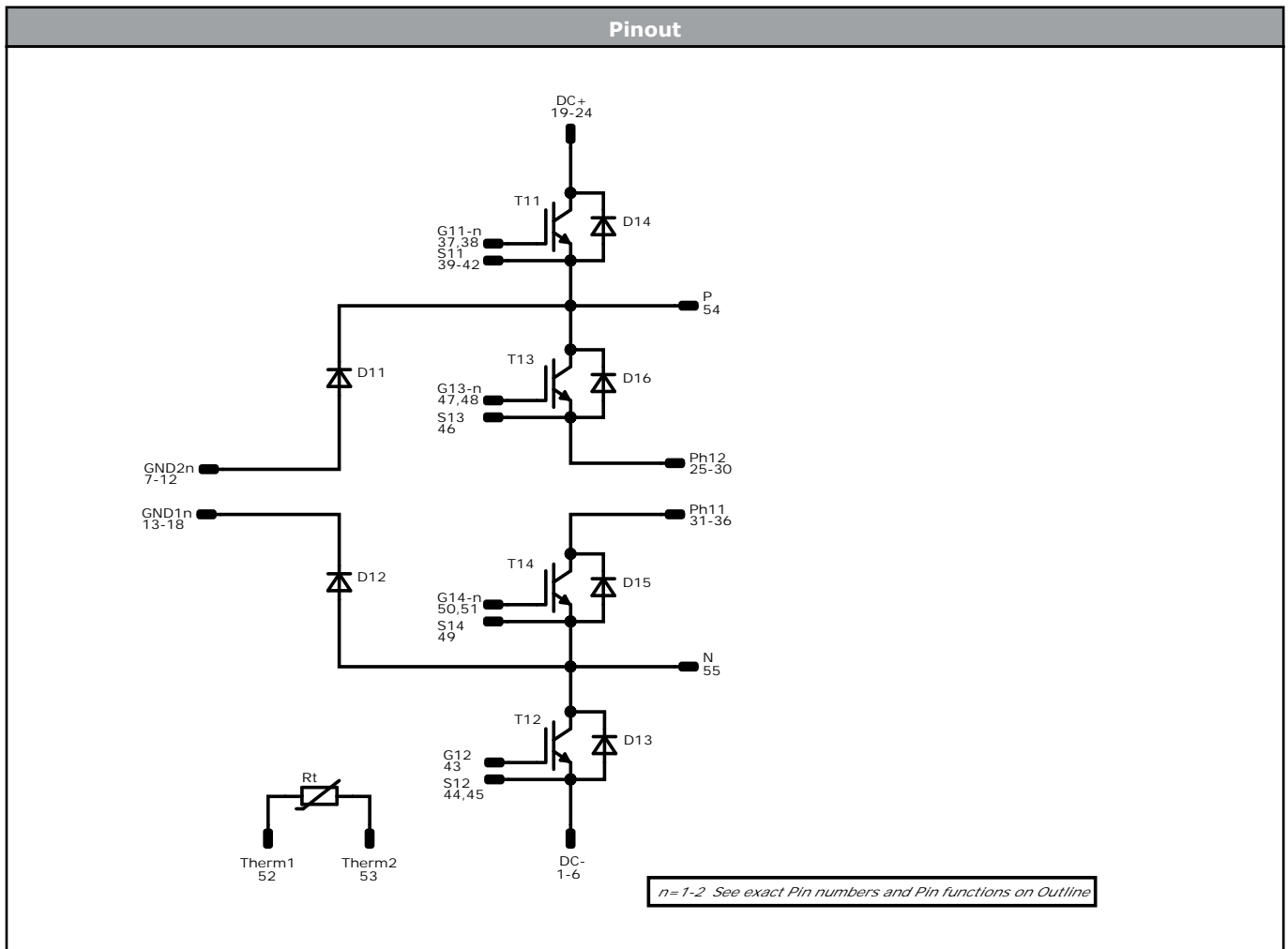

Identification					
ID	Component	Voltage	Current	Function	Comment
T11, T12	IGBT	1200 V	600 A	Buck Switch	Parallel devices with separate control. Values apply to complete device.
D11, D12	FWD	1200 V	160 A	Buck Diode	Parallel devices. Values apply to complete device.
T13, T14	IGBT	1200 V	400 A	Boost Switch	Parallel devices with separate control. Values apply to complete device.
D13, D14	FWD	1200 V	200 A	Boost Diode	Parallel devices. Values apply to complete device.
D16, D15	FWD	1200 V	200 A	Boost Sw. Inv. Diode	
Rt	Thermistor			Thermistor	



Vincotech

Packaging instruction				
Standard packaging quantity (SPQ) 24	>SPQ	Standard	<SPQ	Sample

Handling instruction
Handling instructions for <i>flow</i> E3BP packages see vincotech.com website.

Package data
Package data for <i>flow</i> E3BP packages see vincotech.com website.

Vincotech thermistor reference
See Vincotech thermistor reference table at vincotech.com website.

UL recognition and file number
This device is UL 1557 recognized under E192116 up to a junction temperature under switching condition $T_{j,op}=175^{\circ}\text{C}$ and up to 4000VAC/1min isolation voltage. For more information see vincotech.com website.



Document No.:	Date:	Modification:	Pages
30-EP12NIA600H703-PM00F83T-D1-14	18 Dec. 2024	Initial Release	

DISCLAIMER

The information, specifications, procedures, methods and recommendations herein (together "information") are presented by Vincotech to reader in good faith, are believed to be accurate and reliable, but may well be incomplete and/or not applicable to all conditions or situations that may exist or occur. Vincotech reserves the right to make any changes without further notice to any products to improve reliability, function or design. No representation, guarantee or warranty is made to reader as to the accuracy, reliability or completeness of said information or that the application or use of any of the same will avoid hazards, accidents, losses, damages or injury of any kind to persons or property or that the same will not infringe third parties rights or give desired results. It is reader's sole responsibility to test and determine the suitability of the information and the product for reader's intended use.

LIFE SUPPORT POLICY

Vincotech products are not authorised for use as critical components in life support devices or systems without the express written approval of Vincotech.

As used herein:

1. Life support devices or systems are devices or systems which, (a) are intended for surgical implant into the body, or (b) support or sustain life, or (c) whose failure to perform when properly used in accordance with instructions for use provided in labelling can be reasonably expected to result in significant injury to the user.
2. A critical component is any component of a life support device or system whose failure to perform can be reasonably expected to cause the failure of the life support device or system, or to affect its safety or effectiveness.