



MiniSKiiP® PACK 2

1200 V / 75 A

Topology features

- Inverter
- Kelvin Emitter for improved switching performance
- Tandem inverter diode
- Temperature sensor

Component features

- Easy paralleling
- Low turn-off losses
- Low collector emitter saturation voltage
- Positive temperature coefficient
- Short tail current
- Switching optimized for EMC

Housing features

- Base isolation: Al₂O₃
- Easy assembly in one mounting step
- Flexible PCB design w/o pin holes
- Rugged solderless spring contacts

Target applications

- Elevator Drives
- Industrial Drives
- Servo Drives

Types

- 80-M2126TA075M7-K719F73

MiniSKiiP® 2 16 mm housing

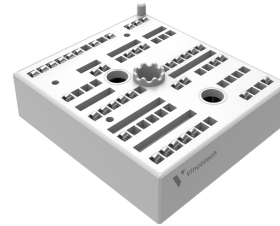

Schematic

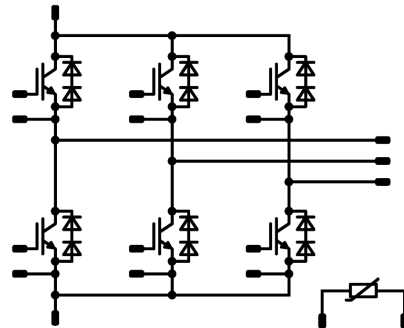



Vincotech

80-M2126TA075M7-K719F73
datasheet

Maximum Ratings

$T_j = 25\text{ °C}$, unless otherwise specified

Parameter	Symbol	Conditions	Value	Unit
Inverter Switch				
Collector-emitter voltage	V_{CES}		1200	V
Collector current (DC current)	I_C	$T_j = T_{jmax}$ $T_s = 80\text{ °C}$	96	A
Repetitive peak collector current	I_{CRM}	t_p limited by T_{jmax}	150	A
Total power dissipation	P_{tot}	$T_j = T_{jmax}$ $T_s = 80\text{ °C}$	196	W
Gate-emitter voltage	V_{GES}		± 20	V
Maximum junction temperature	T_{jmax}		175	°C

Inverter Diode

Peak repetitive reverse voltage	V_{RRM}		1300	V
Forward current (DC current)	I_F	$T_j = T_{jmax}$ $T_s = 80\text{ °C}$	55	A
Repetitive peak forward current	I_{FRM}	t_p limited by T_{jmax}	225	A
Total power dissipation	P_{tot}	$T_j = T_{jmax}$ $T_s = 80\text{ °C}$	136	W
Maximum junction temperature	T_{jmax}		175	°C

Module Properties

Thermal Properties

Storage temperature	T_{stg}		-40...+125	°C
Operation temperature under switching condition	T_{jop}		-40...+($T_{jmax} - 25$)	°C

Isolation Properties

Isolation voltage	V_{isol}	DC Test Voltage* $t_p = 2\text{ s}$	5500	V
Creepage distance		With std lid For more informations see handling instructions	6,3	mm
Clearance		With std lid For more informations see handling instructions	6,3	mm
Comparative Tracking Index	CTI		≥ 600	

*100 % tested in production



Characteristic Values

Parameter	Symbol	Conditions					Values			Unit
		V_{GS} [V]	V_{GE} [V]	V_{DS} [V]	I_D [A]	T_j [°C]	Min	Typ	Max	

Inverter Switch

Static

Gate-emitter threshold voltage	$V_{GE(th)}$			10	0,0075	25	5,4	6	6,6	V
Collector-emitter saturation voltage	$V_{CE(sat)}$		15		75	25 125 150		1,52 1,7 1,74	1,9 ⁽¹⁾	V
Collector-emitter cut-off current	I_{CES}		0	1200		25			100	μA
Gate-emitter leakage current	I_{GES}		20	0		25			500	nA
Internal gate resistance	r_g							4		Ω
Input capacitance	C_{ies}							16000		pF
Output capacitance	C_{oes}		0	10		25		480		pF
Reverse transfer capacitance	C_{res}							190		pF
Gate charge	Q_g	$V_{CC} = 600$ V	0/15		75	25		570		nC

Thermal

Thermal resistance junction to sink ⁽²⁾	$R_{th(j-s)}$	$\lambda_{paste} = 2,5$ W/mK (HPTP)						0,49		K/W
--	---------------	--	--	--	--	--	--	------	--	-----

Dynamic

Turn-on delay time	$t_{d(on)}$					25 125 150		267,56 276,07 278,02		ns
Rise time	t_r					25 125 150		56,87 66,06 68,36		ns
Turn-off delay time	$t_{d(off)}$					25 125 150		233,09 271,61 281,4		ns
Fall time	t_f					25 125 150		75,25 112,68 127,9		ns
Turn-on energy (per pulse)	E_{on}	$Q_{tFWD} = 1,37$ μC $Q_{tFWD} = 3,2$ μC $Q_{tFWD} = 3,76$ μC				25 125 150		4,76 6,89 7,42		mWs
Turn-off energy (per pulse)	E_{off}					25 125 150		5,3 7,71 8,5		mWs



Vincotech

80-M2126TA075M7-K719F73
datasheet

Characteristic Values

Parameter	Symbol	Conditions					Values			Unit
		V_{GE} [V] V_{GS} [V]	V_{CE} [V] V_{DS} [V] V_F [V]	I_C [A] I_D [A] I_F [A]	T_j [°C]	Min	Typ	Max		
Inverter Diode										
Static										
Forward voltage	V_F				75	25 125 150		3,09 2,9 2,84	3,84 ⁽¹⁾	V
Reverse leakage current	I_R	$V_r = 1300$ V				25			3,8	μA
Thermal										
Thermal resistance junction to sink ⁽²⁾	$R_{th(j-s)}$	$\lambda_{paste} = 2,5$ W/mK (HPTP)						0,7		K/W
Dynamic										
Peak recovery current	I_{RM}	$di/dt=1341$ A/μs $di/dt=1090$ A/μs $di/dt=919$ A/μs	±15	600	75	25		19,37		A
Reverse recovery time	t_{rr}					125		29,08		
						150		30,84		
						25		104,27		
Recovered charge	Q_r					125		152,43		
						150		170,37		
		25		1,37						
Reverse recovered energy	E_{rec}	125		3,2						
		150		3,76						
		25		0,352						
Peak rate of fall of recovery current	$(di_r/dt)_{max}$	125		0,845						
		150		1,02						
		25		1152,97						
						125		865,81		A/μs
						150		633,06		



Characteristic Values

Parameter	Symbol	Conditions					Values			Unit
		V_{GS} [V]	V_{GE} [V]	V_{DS} [V]	V_{CE} [V]	T_j [°C]	Min	Typ	Max	

Thermistor

Static

Rated resistance	R					25		1		kΩ
Deviation of R100	$A_{R/R}$	$R_{100} = 1670 \Omega$				100	-2		2	%
Maximum Current	I_{max}							3		mA
Power dissipation constant	d					25		0,76		mW/K
A-value	A							$7,635 \times 10^{-3}$		1/K
B-value	B							$1,73 \times 10^{-5}$		1/K ²
Vincotech Thermistor Reference									E	

⁽¹⁾ Value at chip level

⁽²⁾ Only valid with pre-applied Vincotech thermal interface material.



Inverter Switch Characteristics

figure 1. IGBT

Typical output characteristics

$$I_C = f(V_{CE})$$

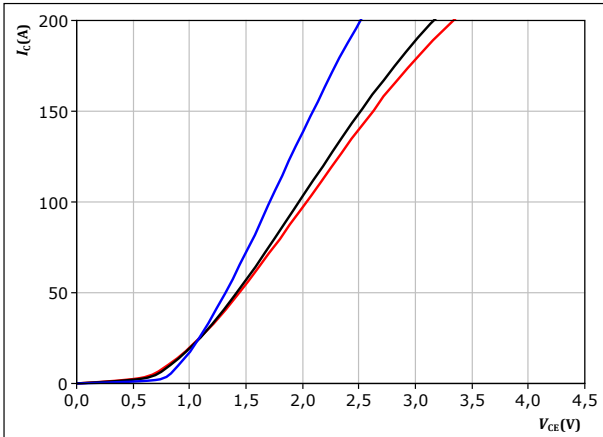

$t_p = 250 \mu\text{s}$
 $V_{GE} = 15 \text{ V}$

$T_j:$ — 25 °C
— 125 °C
— 150 °C

figure 2. IGBT

Typical output characteristics

$$I_C = f(V_{CE})$$

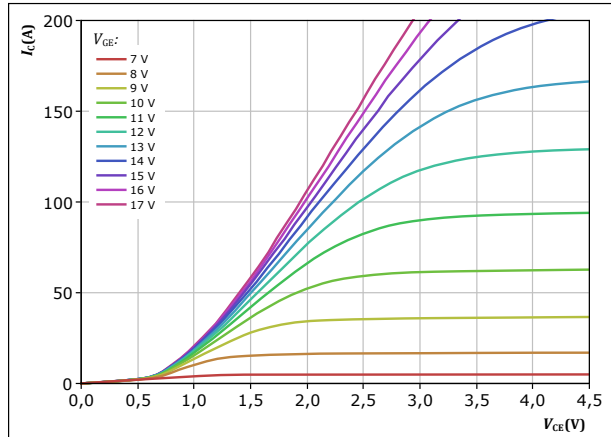

$t_p = 250 \mu\text{s}$
 $T_j = 150^\circ\text{C}$
 V_{GE} from 7 V to 17 V in steps of 1 V

figure 3. IGBT

Typical transfer characteristics

$$I_C = f(V_{GE})$$

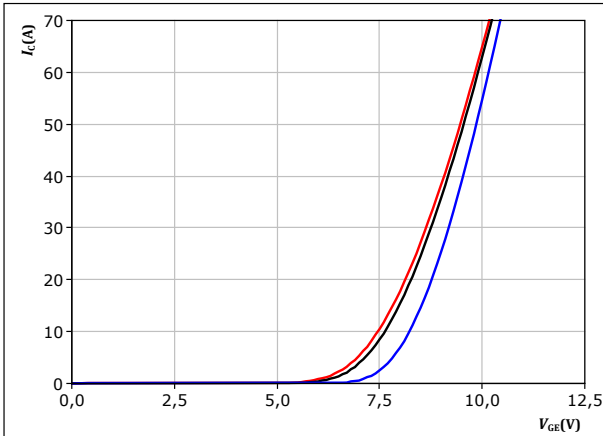

$t_p = 250 \mu\text{s}$
 $V_{CE} = 19 \text{ V}$

$T_j:$ — 25 °C
— 125 °C
— 150 °C

figure 4. IGBT

Transient thermal impedance as a function of pulse width

$$Z_{th(j-s)} = f(t_p)$$

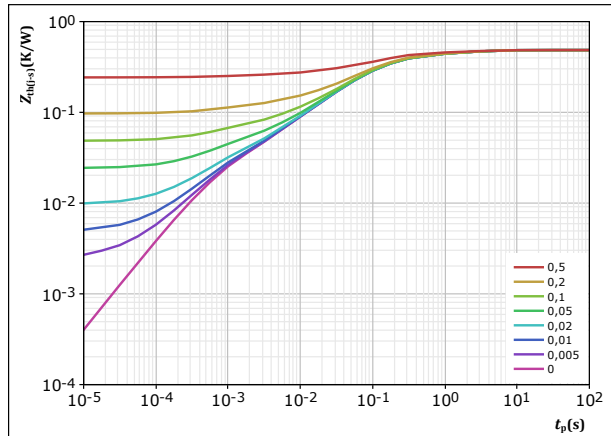

$D = t_p / T$
 $R_{th(j-s)} = 0,485 \text{ K/W}$

IGBT thermal model values

R (K/W)	τ (s)
4,98E-02	2,62E+00
8,75E-02	4,29E-01
2,68E-01	8,30E-02
5,75E-02	1,07E-02
2,23E-02	7,07E-04



Inverter Switch Characteristics

figure 5. IGBT

Safe operating area
 $I_C = f(V_{CE})$

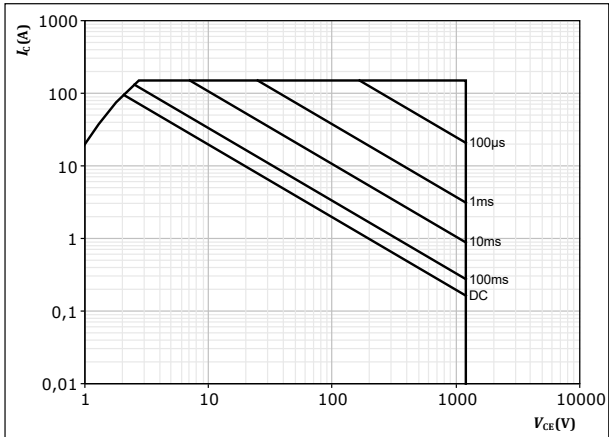

$D =$ single pulse
 $T_s = 80$ °C
 $V_{GE} = 15$ V
 $T_j = T_{jmax}$

figure 6. IGBT

Gate voltage vs gate charge
 $V_{GE} = f(Q_g)$

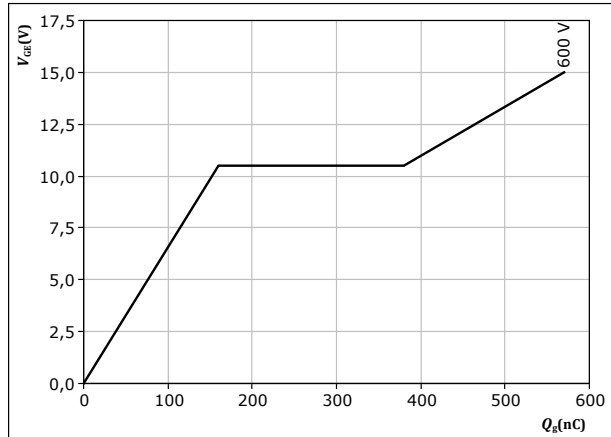

$I_C = 75$ A
 $T_j = 25$ °C



Inverter Diode Characteristics

figure 7. FWD

Typical forward characteristics

$$I_F = f(V_F)$$

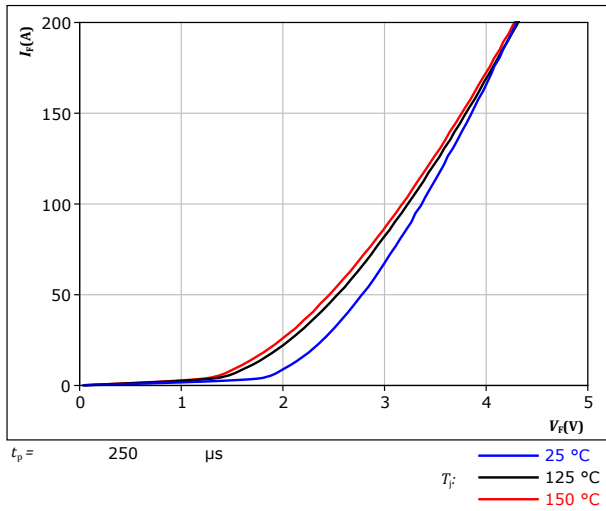
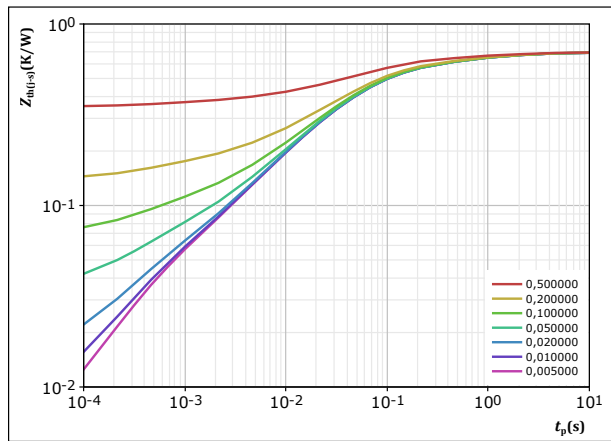

figure 8. FWD

Transient thermal impedance as a function of pulse width

$$Z_{th(j-s)} = f(t_p)$$



$$D = \frac{t_p}{T}$$

$$R_{th(j-s)} = 0,697 \text{ K/W}$$

FWD thermal model values

R (K/W)	τ (s)
8,50E-03	3,16E+01
6,51E-02	1,64E+00
1,12E-01	2,98E-01
3,06E-01	5,67E-02
1,41E-01	1,33E-02
3,76E-02	2,52E-03
3,03E-02	3,88E-04



Thermistor Characteristics

figure 9. Thermistor

Typical PTC characteristic as function of temperature

$$R_T = f(T)$$

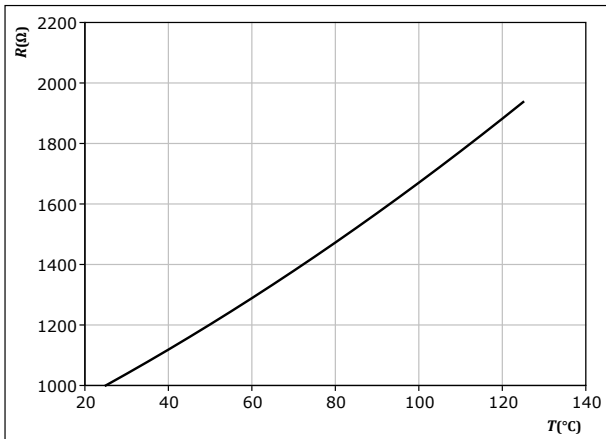



Inverter Switching Characteristics

figure 10. IGBT

Typical switching energy losses as a function of collector current
 $E = f(I_c)$

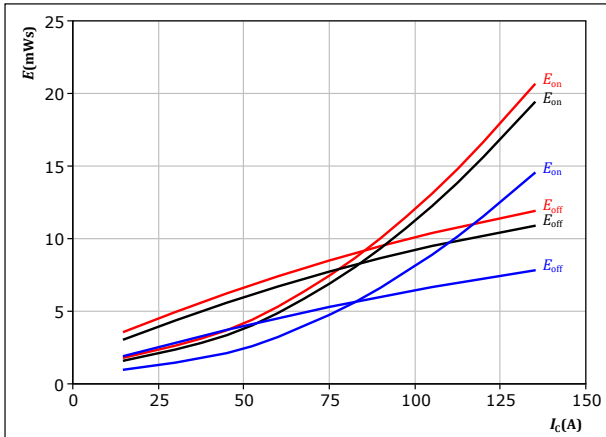

With an inductive load at
 $V_{CE} = 600$ V
 $V_{GE} = \pm 15$ V
 $R_{gon} = 4$ Ω
 $R_{goff} = 4$ Ω

T_j : — 25 °C
 — 125 °C
 — 150 °C

figure 11. IGBT

Typical switching energy losses as a function of IGBT turn on gate resistor
 $E = f(R_g)$

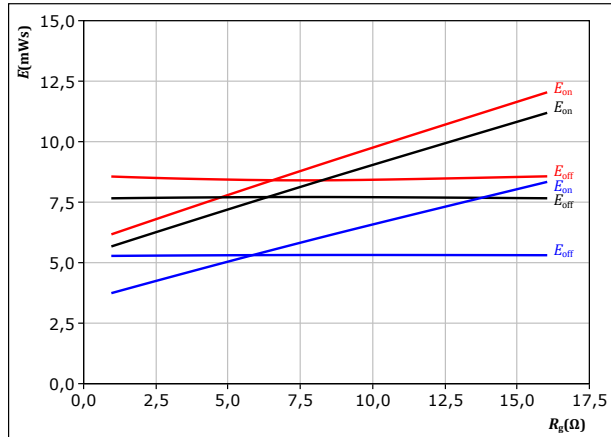

With an inductive load at
 $V_{CE} = 600$ V
 $V_{GE} = \pm 15$ V
 $I_c = 75$ A

T_j : — 25 °C
 — 125 °C
 — 150 °C

figure 12. FWD

Typical reverse recovered energy loss as a function of collector current
 $E_{rec} = f(I_c)$

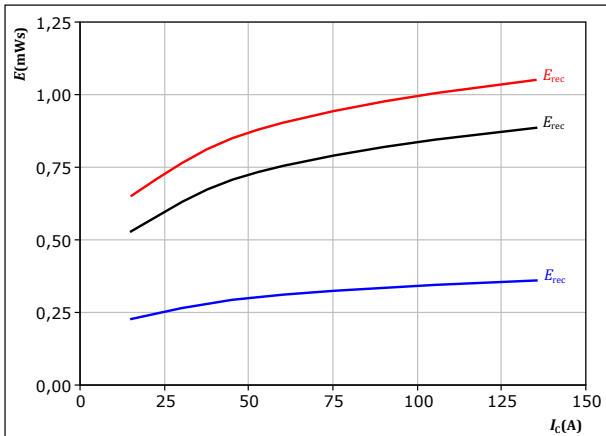

With an inductive load at
 $V_{CE} = 600$ V
 $V_{GE} = \pm 15$ V
 $R_{gon} = 4$ Ω

T_j : — 25 °C
 — 125 °C
 — 150 °C

figure 13. FWD

Typical reverse recovered energy loss as a function of IGBT turn on gate resistor
 $E_{rec} = f(R_g)$

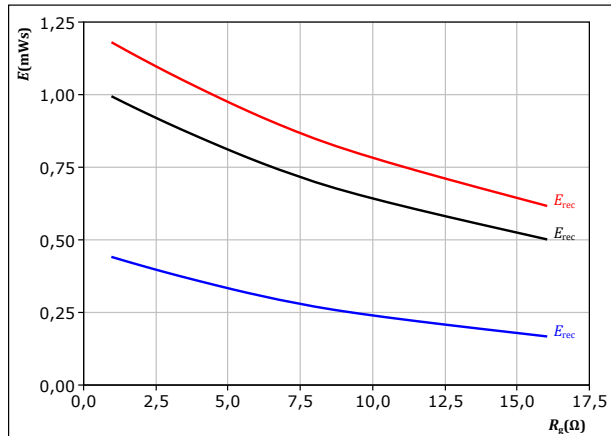

With an inductive load at
 $V_{CE} = 600$ V
 $V_{GE} = \pm 15$ V
 $I_c = 75$ A

T_j : — 25 °C
 — 125 °C
 — 150 °C



Inverter Switching Characteristics

figure 14. IGBT

Typical switching times as a function of collector current
 $t = f(I_c)$

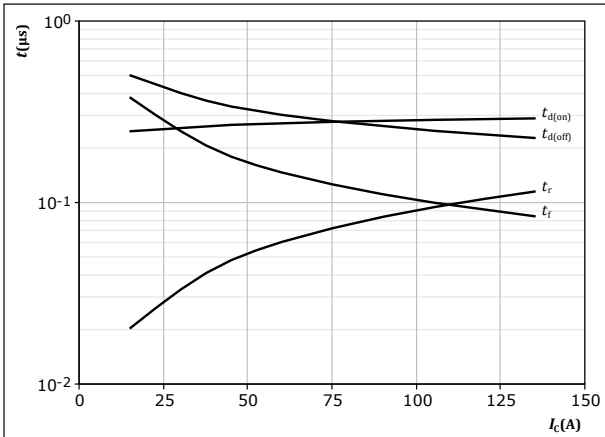

With an inductive load at
 $T_j = 150$ °C
 $V_{CE} = 600$ V
 $V_{GE} = \pm 15$ V
 $R_{gon} = 4$ Ω
 $R_{goff} = 4$ Ω

figure 15. IGBT

Typical switching times as a function of IGBT turn on gate resistor
 $t = f(R_g)$

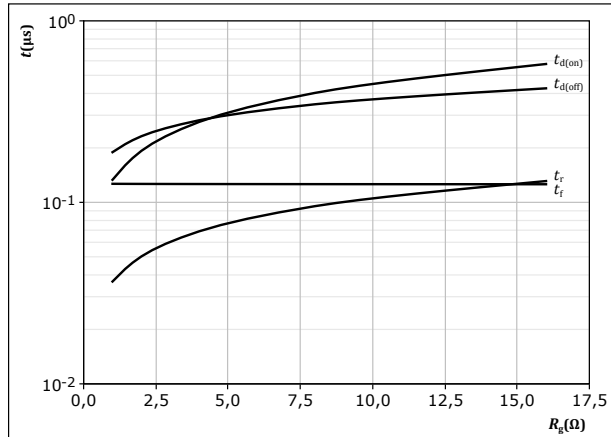

With an inductive load at
 $T_j = 150$ °C
 $V_{CE} = 600$ V
 $V_{GE} = \pm 15$ V
 $I_c = 75$ A

figure 16. FWD

Typical reverse recovery time as a function of collector current
 $t_{rr} = f(I_c)$

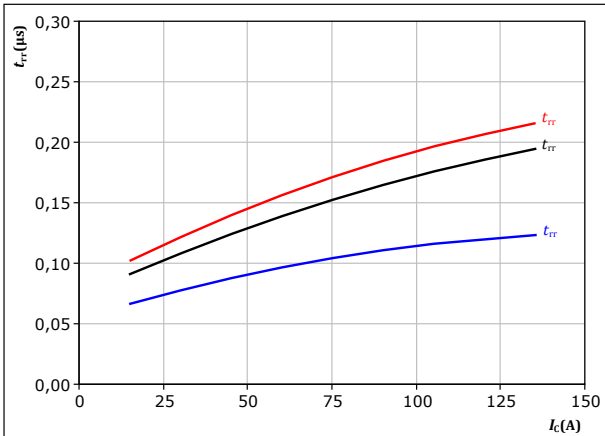

With an inductive load at
 $V_{CE} = 600$ V
 $V_{GE} = \pm 15$ V
 $R_{gon} = 4$ Ω
 T_j : — 25 °C
— 125 °C
— 150 °C

figure 17. FWD

Typical reverse recovery time as a function of IGBT turn on gate resistor
 $t_{rr} = f(R_{gon})$

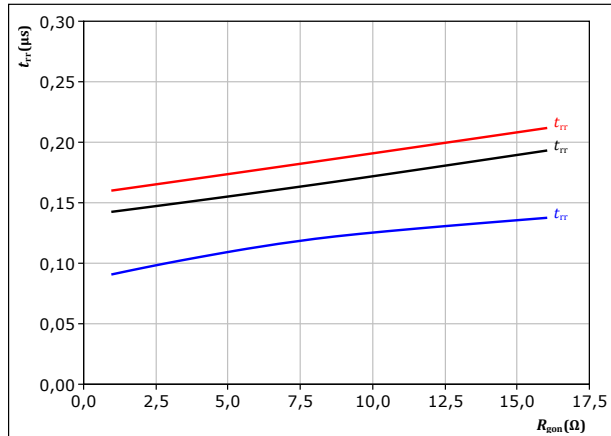

With an inductive load at
 $V_{CE} = 600$ V
 $V_{GE} = \pm 15$ V
 $I_c = 75$ A
 T_j : — 25 °C
— 125 °C
— 150 °C



Inverter Switching Characteristics

figure 18. FWD

Typical recovered charge as a function of collector current

$$Q_r = f(I_c)$$

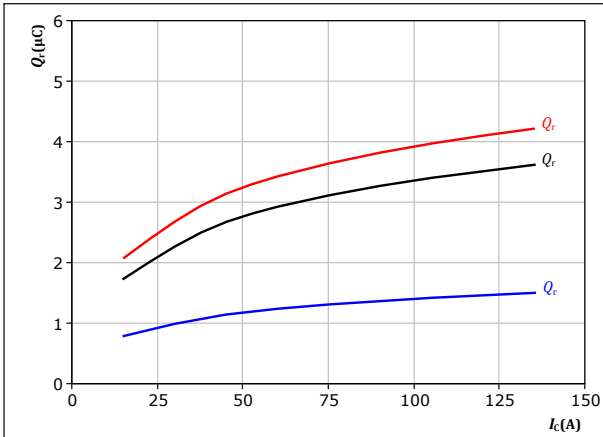

With an inductive load at

$V_{CE} = 600 \text{ V}$
 $V_{GE} = \pm 15 \text{ V}$
 $R_{gon} = 4 \ \Omega$
 $T_j: 25 \text{ }^\circ\text{C}$
 $125 \text{ }^\circ\text{C}$
 $150 \text{ }^\circ\text{C}$

figure 20. FWD

Typical peak reverse recovery current as a function of collector current

$$I_{RM} = f(I_c)$$

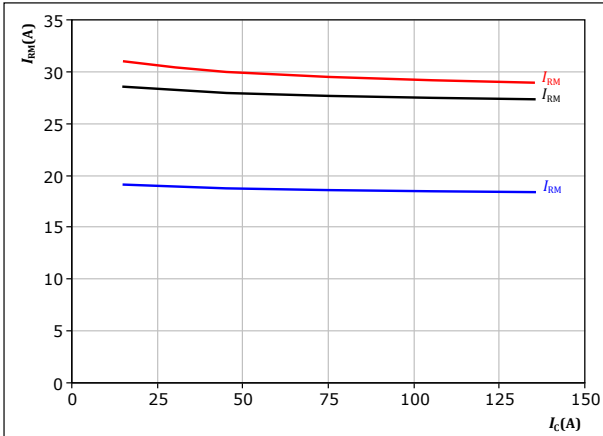

With an inductive load at

$V_{CE} = 600 \text{ V}$
 $V_{GE} = \pm 15 \text{ V}$
 $R_{gon} = 4 \ \Omega$
 $T_j: 25 \text{ }^\circ\text{C}$
 $125 \text{ }^\circ\text{C}$
 $150 \text{ }^\circ\text{C}$

figure 19. FWD

Typical recovered charge as a function of IGBT turn on gate resistor

$$Q_r = f(R_{gon})$$

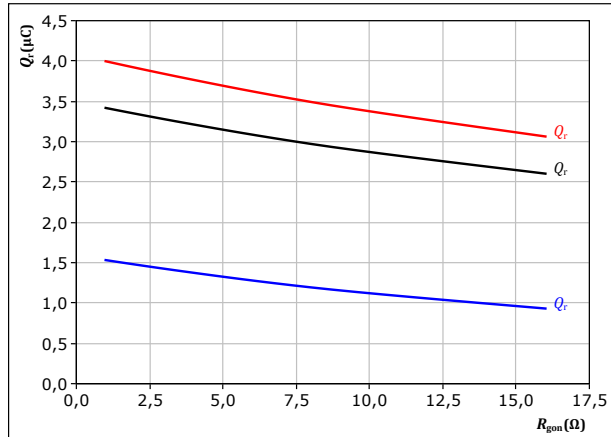

With an inductive load at

$V_{CE} = 600 \text{ V}$
 $V_{GE} = \pm 15 \text{ V}$
 $I_c = 75 \text{ A}$
 $T_j: 25 \text{ }^\circ\text{C}$
 $125 \text{ }^\circ\text{C}$
 $150 \text{ }^\circ\text{C}$

figure 21. FWD

Typical peak reverse recovery current as a function of IGBT turn on gate resistor

$$I_{RM} = f(R_{gon})$$

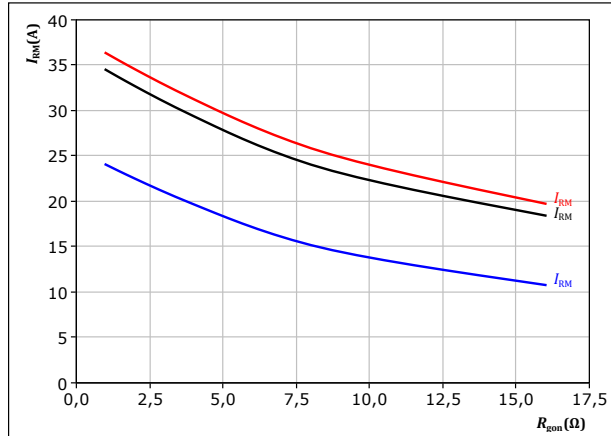

With an inductive load at

$V_{CE} = 600 \text{ V}$
 $V_{GE} = \pm 15 \text{ V}$
 $I_c = 75 \text{ A}$
 $T_j: 25 \text{ }^\circ\text{C}$
 $125 \text{ }^\circ\text{C}$
 $150 \text{ }^\circ\text{C}$



Inverter Switching Characteristics

figure 22. FWD

Typical rate of fall of forward and reverse recovery current as a function of collector current
 $di_f/dt, di_{rr}/dt = f(I_c)$

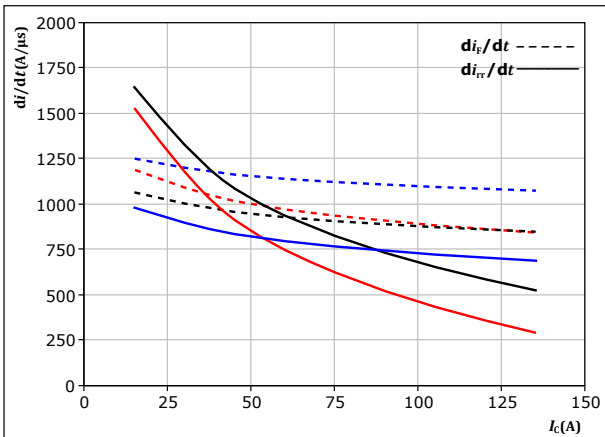

With an inductive load at

$V_{CE} =$	600	V	$T_j:$	25 °C
$V_{GE} =$	±15	V		125 °C
$R_{gon} =$	4	Ω		150 °C

figure 23. FWD

Typical rate of fall of forward and reverse recovery current as a function of turn on gate resistor
 $di_f/dt, di_{rr}/dt = f(R_{gon})$

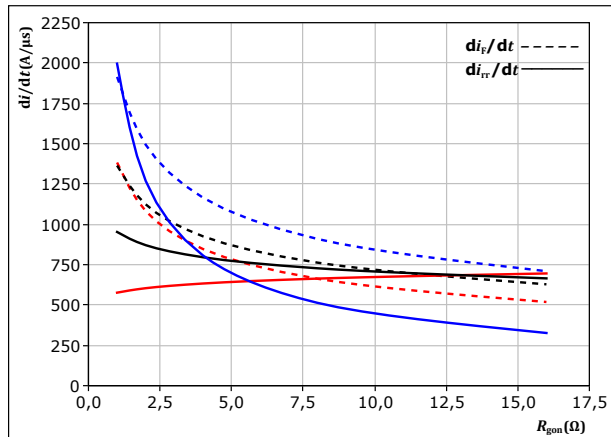

With an inductive load at

$V_{CE} =$	600	V	$T_j:$	25 °C
$V_{GE} =$	±15	V		125 °C
$I_c =$	75	A		150 °C

figure 24. IGBT

Reverse bias safe operating area
 $I_c = f(V_{CE})$

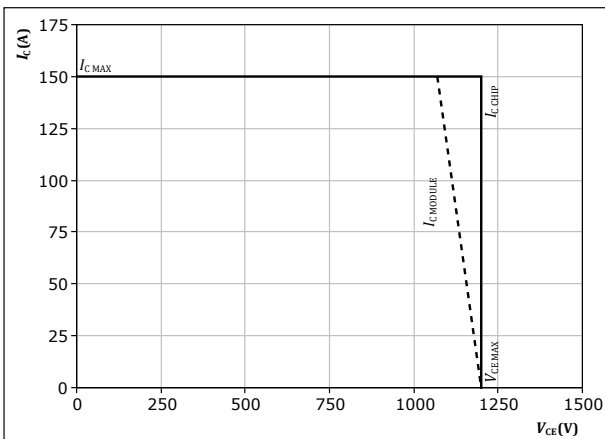

At $T_j = 150$ °C
 $R_{gon} = 4$ Ω
 $R_{goff} = 4$ Ω



Inverter Switching Definitions

figure 25. IGBT

Turn-off Switching Waveforms & definition of t_{doff} , t_{Eoff} (t_{Eoff} = integrating time for E_{off})

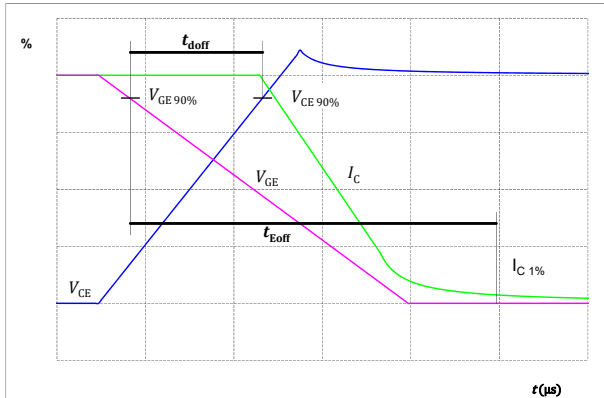

figure 26. IGBT

Turn-on Switching Waveforms & definition of t_{don} , t_{Eon} (t_{Eon} = integrating time for E_{on})

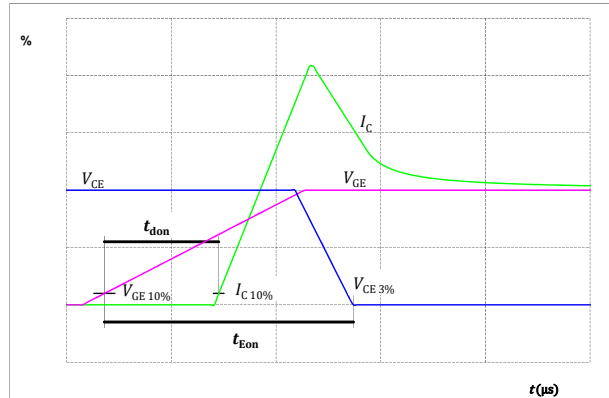

figure 27. IGBT

Turn-off Switching Waveforms & definition of t_f

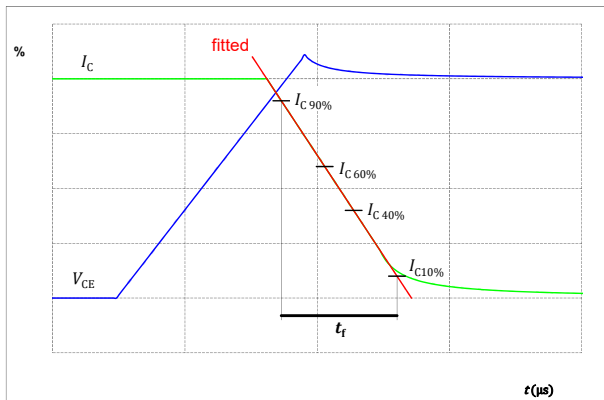
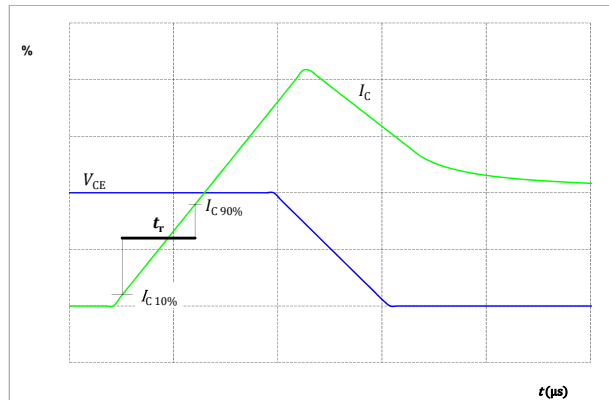

figure 28. IGBT

Turn-on Switching Waveforms & definition of t_r





Inverter Switching Definitions

figure 29. FWD

Turn-off Switching Waveforms & definition of t_{rr}

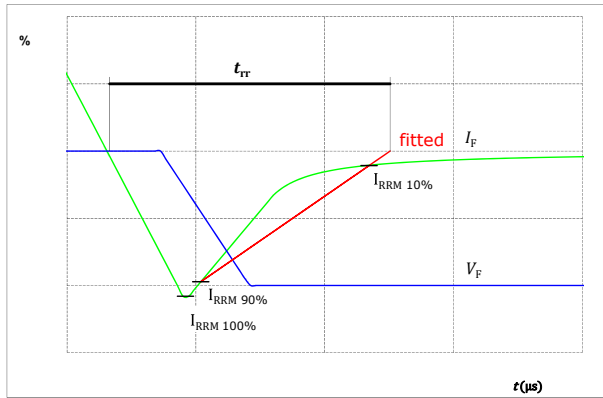
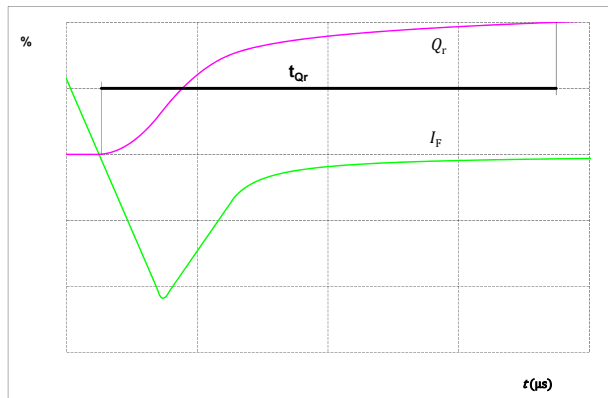

figure 30. FWD

Turn-on Switching Waveforms & definition of t_{Qr} (t_{Qr} = integrating time for Q_r)





Vincotech

Ordering Code	
Version	Ordering Code
With std lid (6.5mm height) + no thermal grease	80-M2126TA075M7-K719F73-/0A/
With thin lid (2.8mm height) + no thermal grease	80-M2126TA075M7-K719F73-/0B/
With std lid (6.5mm height) + thermal grease (0,8 W/mK, P12, silicone-based)	80-M2126TA075M7-K719F73-/1A/
With thin lid (2.8mm height) + thermal grease (0,8 W/mK, P12, silicone-based)	80-M2126TA075M7-K719F73-/1B/
With std lid (6.5mm height) + thermal grease (2,5 W/mK, TG20032, silicone-free)	80-M2126TA075M7-K719F73-/4A/
With thin lid (2.8mm height) + thermal grease (2,5 W/mK, TG20032, silicone-free)	80-M2126TA075M7-K719F73-/4B/
With std lid (6.5mm height) + thermal grease (2,5 W/mK, HPTP, silicone-based)	80-M2126TA075M7-K719F73-/5A/
With thin lid (2.8mm height) + thermal grease (2,5 W/mK, HPTP, silicone-based)	80-M2126TA075M7-K719F73-/5B/

Marking						
Text	Name		Date code	UL & VIN	Lot	Serial
		NN-NNNNNNNNNNNNNN- TTTTTTTV		WWYY	UL VIN	LLLLL
Datamatrix		Type&Ver	Lot number	Serial	Date code	
	TTTTTTTV	LLLLL	SSSS	WWYY		

Outline							
Pin table [mm]							
Pin	X	Y	Function	34	not assembled		
1	24,38	-21,8	DC+123	35	0,03	9	Ph1
2	24,38	-18,6	DC+123	36	0,03	12,2	Ph1
3	24,38	-15,4	DC+123	37	0,03	15,4	Ph1
4	24,38	-12,2	DC+123	38	0,03	18,6	Ph1
5	24,38	-9	DC+123	39	0,03	21,8	Ph1
6	not assembled			40	-8,5	-21,8	Ph3
7	not assembled			41	not assembled		
8	24,38	12,2	Therm1	42	not assembled		
9	not assembled			43	not assembled		
10	not assembled			44	-12,22	-9	Ph2
11	24,38	21,8	Therm2	45	-12,22	-5,8	Ph2
12	not assembled			46	not assembled		
13	not assembled			47	-12,22	3,9	Ph2
14	not assembled			48	-12,22	7,1	Ph2
15	not assembled			49	-12,22	10,3	Ph2
16	13,42	-21,8	G16	50	not assembled		
17	not assembled			51	not assembled		
18	not assembled			52	not assembled		
19	not assembled			53	-24,38	-21,8	G15
20	not assembled			54	-24,38	-18,6	S15
21	not assembled			55	-24,38	-15,4	DC-123
22	8,38	2,6	S14	56	-24,38	-12,2	DC-123
23	8,38	5,8	G14	57	-24,38	-9	DC-123
24	not assembled			58	-24,38	-5,8	S13
25	not assembled			59	not assembled		
26	8,38	18,6	S12	60	-24,38	0,7	G13
27	8,38	21,8	G12	61	not assembled		
28	2,46	-21,8	S16	62	-24,38	7,1	DC-123
29	2,46	-18,6	Ph3	63	-24,38	15,4	DC-123
30	2,46	-15,4	Ph3	64	-24,38	18,6	S11
31	2,46	-12,2	Ph3	65	-24,38	21,8	G11
32	2,46	-9	Ph3				
33	not assembled						

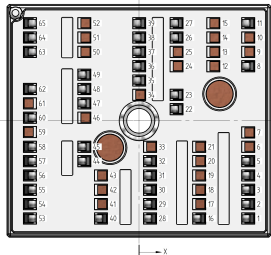

Pad positions refers to center point. For more informations on pad design please see package data



Vincotech

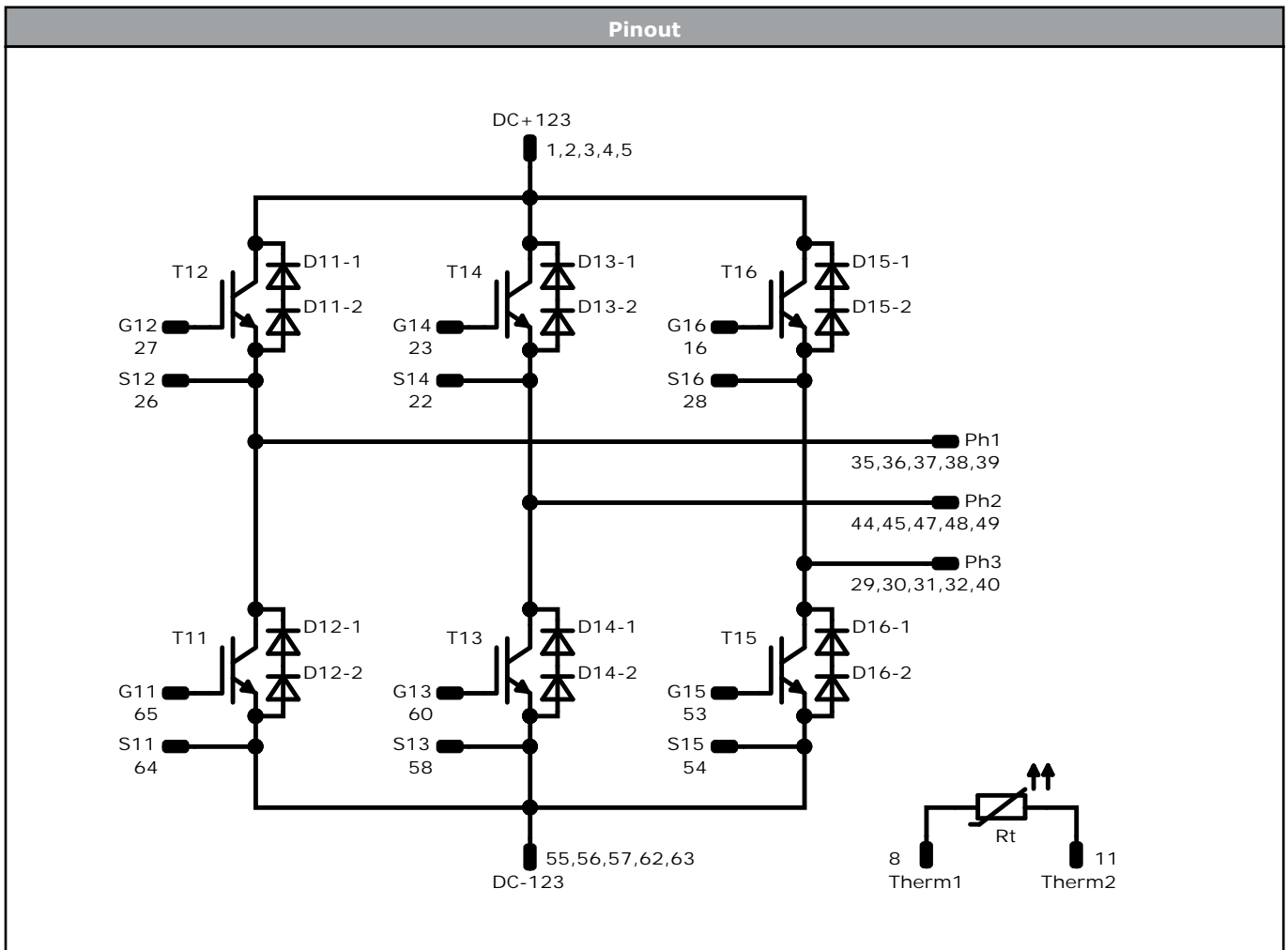

Identification					
ID	Component	Voltage	Current	Function	Comment
T11, T12, T13, T14, T15, T16	IGBT	1200 V	75 A	Inverter Switch	
D11, D12, D13, D14, D15, D16	FWD	1300 V	75 A	Inverter Diode	
Rt	PTC			Thermistor	



Packaging instruction				
Standard packaging quantity (SPQ) 72	>SPQ	Standard	<SPQ	Sample

Handling instruction
Handling instructions for MiniSKiiP® 2 packages see vincotech.com website.

Package data
Package data for MiniSKiiP® 2 packages see vincotech.com website.

Vincotech thermistor reference
See Vincotech thermistor reference table at vincotech.com website.

UL recognition and file number
This device is UL 1557 recognized under E192116 up to a junction temperature under switching condition $T_{j,op}=150^{\circ}C$ and up to 2500VAC/1min isolation voltage. For more information see vincotech.com website.



Document No.:	Date:	Modification:	Pages
80-M2126TA075M7-K719F73-D1-14	11 Dec. 2024	Initial Release	

DISCLAIMER

The information, specifications, procedures, methods and recommendations herein (together "information") are presented by Vincotech to reader in good faith, are believed to be accurate and reliable, but may well be incomplete and/or not applicable to all conditions or situations that may exist or occur. Vincotech reserves the right to make any changes without further notice to any products to improve reliability, function or design. No representation, guarantee or warranty is made to reader as to the accuracy, reliability or completeness of said information or that the application or use of any of the same will avoid hazards, accidents, losses, damages or injury of any kind to persons or property or that the same will not infringe third parties rights or give desired results. It is reader's sole responsibility to test and determine the suitability of the information and the product for reader's intended use.

LIFE SUPPORT POLICY

Vincotech products are not authorised for use as critical components in life support devices or systems without the express written approval of Vincotech.

As used herein:

1. Life support devices or systems are devices or systems which, (a) are intended for surgical implant into the body, or (b) support or sustain life, or (c) whose failure to perform when properly used in accordance with instructions for use provided in labelling can be reasonably expected to result in significant injury to the user.
2. A critical component is any component of a life support device or system whose failure to perform can be reasonably expected to cause the failure of the life support device or system, or to affect its safety or effectiveness.