



flowBOOST S3 dual

950 V / 200 A

Topology features

- Auxiliary diodes for FC pre-charge (patent pending)
- Dual Flying Cap Booster
- Kelvin Emitter for improved switching performance
- Temperature sensor

Component features

- Low collector emitter saturation voltage
- High speed and smooth switching

Housing features

- Base isolation: Al₂O₃
- CTI600 housing material
- Compact, baseplate-less housing
- VINcoPress Technology
- Thermo-mechanical push-and-pull force relief
- Press-fit pin
- Reliable cold welding connection

Target applications

- Energy Storage Systems
- Solar Inverters

Types

- B0-SP10B2A200S704-PA58L98T

flow S3 12 mm housing



Schematic

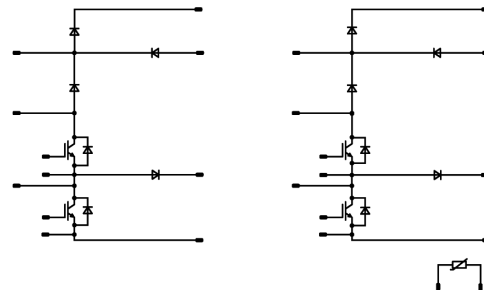



Vincotech

Maximum Ratings

$T_j = 25\text{ °C}$, unless otherwise specified

Parameter	Symbol	Conditions	Value	Unit
Inner Boost Switch				
Collector-emitter voltage	V_{CES}		950	V
Collector current (DC current)	I_C	$T_j = T_{jmax}$ $T_s = 80\text{ °C}$	145	A
Repetitive peak collector current	I_{CRM}	t_p limited by T_{jmax}	400	A
Total power dissipation	P_{tot}	$T_j = T_{jmax}$ $T_s = 80\text{ °C}$	276	W
Gate-emitter voltage	V_{GES}		± 20	V
Maximum junction temperature	T_{jmax}		175	°C

Inner Boost Diode

Peak repetitive reverse voltage	V_{RRM}		1200	V
Forward current (DC current)	I_F	$T_j = T_{jmax}$ $T_s = 80\text{ °C}$	72	A
Repetitive peak forward current	I_{FRM}	t_p limited by T_{jmax}	273	A
Surge (non-repetitive) forward current	I_{FSM}	Single Half Sine Wave, $t_p = 10\text{ ms}$ $T_j = 25\text{ °C}$	390	A
Total power dissipation	P_{tot}	$T_j = T_{jmax}$ $T_s = 80\text{ °C}$	168	W
Maximum junction temperature	T_{jmax}		175	°C

Inner Boost Sw. Protection Diode

Peak repetitive reverse voltage	V_{RRM}		1200	V
Forward current (DC current)	I_F	$T_j = T_{jmax}$ $T_s = 80\text{ °C}$	67	A
Repetitive peak forward current	I_{FRM}	t_p limited by T_{jmax}	150	A
Total power dissipation	P_{tot}	$T_j = T_{jmax}$ $T_s = 80\text{ °C}$	120	W
Maximum junction temperature	T_{jmax}		175	°C



Vincotech

Maximum Ratings

$T_j = 25\text{ °C}$, unless otherwise specified

Parameter	Symbol	Conditions	Value	Unit
-----------	--------	------------	-------	------

Outer Boost Switch

Collector-emitter voltage	V_{CES}		950	V
Collector current (DC current)	I_C	$T_j = T_{jmax}$ $T_s = 80\text{ °C}$	145	A
Repetitive peak collector current	I_{CRM}	t_p limited by T_{jmax}	400	A
Total power dissipation	P_{tot}	$T_j = T_{jmax}$ $T_s = 80\text{ °C}$	276	W
Gate-emitter voltage	V_{GES}		± 20	V
Maximum junction temperature	T_{jmax}		175	°C

Outer Boost Diode

Peak repetitive reverse voltage	V_{RRM}		1200	V
Forward current (DC current)	I_F	$T_j = T_{jmax}$ $T_s = 80\text{ °C}$	72	A
Repetitive peak forward current	I_{FRM}	t_p limited by T_{jmax}	273	A
Surge (non-repetitive) forward current	I_{FSM}	Single Half Sine Wave, $t_p = 10\text{ ms}$ $T_j = 25\text{ °C}$	390	A
Total power dissipation	P_{tot}	$T_j = T_{jmax}$ $T_s = 80\text{ °C}$	168	W
Maximum junction temperature	T_{jmax}		175	°C

Outer Boost Sw. Protection Diode

Peak repetitive reverse voltage	V_{RRM}		1200	V
Forward current (DC current)	I_F	$T_j = T_{jmax}$ $T_s = 80\text{ °C}$	67	A
Repetitive peak forward current	I_{FRM}	t_p limited by T_{jmax}	150	A
Total power dissipation	P_{tot}	$T_j = T_{jmax}$ $T_s = 80\text{ °C}$	120	W
Maximum junction temperature	T_{jmax}		175	°C



Vincotech

Maximum Ratings

$T_j = 25\text{ °C}$, unless otherwise specified

Parameter	Symbol	Conditions	Value	Unit
Aux Diode H				
Peak repetitive reverse voltage	V_{RRM}		1200	V
Forward current (DC current)	I_F	$T_j = T_{jmax}$ $T_s = 80\text{ °C}$	43	A
Surge (non-repetitive) forward current	I_{FSM}	Single Half Sine Wave, $t_p = 10\text{ ms}$ $T_j = 150\text{ °C}$	270	A
Surge current capability	I^2t		365	A ² s
Total power dissipation	P_{tot}	$T_j = T_{jmax}$ $T_s = 80\text{ °C}$	91	W
Maximum junction temperature	T_{jmax}		175	°C

Aux Diode L

Peak repetitive reverse voltage	V_{RRM}		1200	V
Forward current (DC current)	I_F	$T_j = T_{jmax}$ $T_s = 80\text{ °C}$	43	A
Surge (non-repetitive) forward current	I_{FSM}	Single Half Sine Wave, $t_p = 10\text{ ms}$ $T_j = 150\text{ °C}$	270	A
Surge current capability	I^2t		365	A ² s
Total power dissipation	P_{tot}	$T_j = T_{jmax}$ $T_s = 80\text{ °C}$	91	W
Maximum junction temperature	T_{jmax}		175	°C

Module Properties

Thermal Properties

Storage temperature	T_{stg}		-40...+125	°C
Operation temperature under switching condition	T_{jop}		-40...+($T_{jmax} - 25$)	°C

Isolation Properties

Isolation voltage	V_{isol}	DC Test Voltage* $t_p = 2\text{ s}$	6000	V
Creepage distance			9,77	mm
Clearance			9,77	mm
Comparative Tracking Index	CTI		≥ 600	

*100 % tested in production



Vincotech

Characteristic Values

Parameter	Symbol	Conditions					Values			Unit
		V_{GE} [V] V_{GS} [V]	V_{CE} [V] V_{DS} [V] V_F [V]	I_C [A] I_D [A] I_F [A]	T_j [°C]	Min	Typ	Max		

Inner Boost Switch

Static

Gate-emitter threshold voltage	$V_{GE(th)}$	$V_{CE} = V_{GE}$			0,00334	25	4,35	5,1	5,85	V
Collector-emitter saturation voltage	$V_{CE(sat)}$		15		200	25 125 150		1,83 2,06 2,11	2,35 ⁽¹⁾	V
Collector-emitter cut-off current	I_{CES}		0	950		25			4	μA
Gate-emitter leakage current	I_{GES}		20	0		25			200	nA
Internal gate resistance	r_g							0,75		Ω
Input capacitance	C_{ies}							13000		pF
Output capacitance	C_{oes}	$f = 100$ kHz	0	25		25		278		pF
Reverse transfer capacitance	C_{res}							40		pF
Gate charge	Q_g		±15		0	25		460		nC

Thermal

Thermal resistance junction to sink ⁽²⁾	$R_{th(j-s)}$	$\lambda_{paste} = 5,2$ W/mK (PTM)						0,34		K/W
--	---------------	---------------------------------------	--	--	--	--	--	------	--	-----

Dynamic

Turn-on delay time	$t_{d(on)}$					25 125 150		259,9 258,86 258,6		ns
Rise time	t_r	$R_{gon} = 8$ Ω $R_{goff} = 8$ Ω				25 125 150		25,92 28,8 30,29		ns
Turn-off delay time	$t_{d(off)}$		±15	600	135	25 125 150		193,14 224,38 233,5		ns
Fall time	t_f					25 125 150		22,27 45,76 54,07		ns
Turn-on energy (per pulse)	E_{on}	$Q_{tFWD} = 0,271$ μC $Q_{tFWD} = 0,273$ μC $Q_{tFWD} = 0,272$ μC				25 125 150		5,49 5,4 5,42		mWs
Turn-off energy (per pulse)	E_{off}					25 125 150		3,2 5,36 6		mWs



Vincotech

Characteristic Values

Parameter	Symbol	Conditions					Values			Unit
		V_{GE} [V] V_{GS} [V]	V_{CE} [V] V_{DS} [V] V_F [V]	I_C [A] I_D [A] I_F [A]	T_j [°C]	Min	Typ	Max		
Inner Boost Diode										
Static										
Forward voltage	V_F			60	25 125 150		1,5 1,86 2,01	1,8 ⁽¹⁾		V
Reverse leakage current	I_R	$V_r = 1200$ V			25		105	600		μA
Thermal										
Thermal resistance junction to sink ⁽²⁾	$R_{th(j-s)}$	$\lambda_{paste} = 5,2$ W/mK (PTM)					0,57			K/W
Dynamic										
Peak recovery current	I_{RM}				25 125 150		29,31 28,88 28,56			A
Reverse recovery time	t_{rr}				25 125 150		15,13 15,51 15,64			ns
Recovered charge	Q_r	$di/dt=4162$ A/μs $di/dt=4717$ A/μs $di/dt=4994$ A/μs	±15	600	135	25 125 150	0,271 0,273 0,272			μC
Reverse recovered energy	E_{rec}				25 125 150		0,033 0,033 0,033			mWs
Peak rate of fall of recovery current	$(di_r/dt)_{max}$				25 125 150		10460,35 8703,36 7469,31			A/μs



Vincotech

Characteristic Values

Parameter	Symbol	Conditions					Values			Unit
		V_{GE} [V] V_{GS} [V]	V_{CE} [V] V_{DS} [V] V_F [V]	I_C [A] I_D [A] I_F [A]	T_j [°C]	Min	Typ	Max		

Inner Boost Sw. Protection Diode

Static

Forward voltage	V_F				75	25 125 150		1,74 1,83 1,84	2,15 ⁽¹⁾	V
Reverse leakage current	I_R	$V_r = 1200$ V				25			55	μA

Thermal

Thermal resistance junction to sink ⁽²⁾	$R_{th(j-s)}$	$\lambda_{paste} = 5,2$ W/mK (PTM)						0,79		K/W
--	---------------	---------------------------------------	--	--	--	--	--	------	--	-----



Vincotech

Characteristic Values

Parameter	Symbol	Conditions					Values			Unit
		V_{GE} [V] V_{GS} [V]	V_{CE} [V] V_{DS} [V] V_F [V]	I_C [A] I_D [A] I_F [A]	T_j [°C]	Min	Typ	Max		

Outer Boost Switch

Static

Gate-emitter threshold voltage	$V_{GE(th)}$	$V_{CE} = V_{GE}$			0,00334	25	4,35	5,1	5,85	V
Collector-emitter saturation voltage	$V_{CE(sat)}$		15		200	25 125 150		1,83 2,06 2,11	2,35 ⁽¹⁾	V
Collector-emitter cut-off current	I_{CES}		0	950		25			4	μA
Gate-emitter leakage current	I_{GES}		20	0		25			200	nA
Internal gate resistance	r_g							0,75		Ω
Input capacitance	C_{ies}							13000		pF
Output capacitance	C_{oes}	$f = 100$ kHz	0	25		25		278		pF
Reverse transfer capacitance	C_{res}							40		pF
Gate charge	Q_g		±15		0	25		460		nC

Thermal

Thermal resistance junction to sink ⁽²⁾	$R_{th(j-s)}$	$\lambda_{paste} = 5,2$ W/mK (PTM)						0,34		K/W
--	---------------	---------------------------------------	--	--	--	--	--	------	--	-----

Dynamic

Turn-on delay time	$t_{d(on)}$					25 125 150		259,9 258,86 258,6		ns
Rise time	t_r					25 125 150		25,92 28,8 30,29		ns
Turn-off delay time	$t_{d(off)}$					25 125 150		193,14 224,38 233,5		ns
Fall time	t_f					25 125 150		22,27 45,76 54,07		ns
Turn-on energy (per pulse)	E_{on}	$Q_{tFWD} = 0,271$ μC $Q_{tFWD} = 0,273$ μC $Q_{tFWD} = 0,272$ μC				25 125 150		5,49 5,4 5,42		mWs
Turn-off energy (per pulse)	E_{off}					25 125 150		3,2 5,36 6		mWs



Vincotech

B0-SP10B2A200S704-PA58L98T
datasheet

Characteristic Values

Parameter	Symbol	Conditions					Values			Unit
		V_{GE} [V] V_{GS} [V]	V_{CE} [V] V_{DS} [V] V_F [V]	I_C [A] I_D [A] I_F [A]	T_j [°C]	Min	Typ	Max		
Outer Boost Diode										
Static										
Forward voltage	V_F			60	25 125 150		1,5 1,86 2,01	1,8 ⁽¹⁾		V
Reverse leakage current	I_R	$V_r = 1200$ V			25		105	600		μA
Thermal										
Thermal resistance junction to sink ⁽²⁾	$R_{th(j-s)}$	$\lambda_{paste} = 5,2$ W/mK (PTM)					0,57			K/W
Dynamic										
Peak recovery current	I_{RM}				25 125 150		29,31 28,88 28,56			A
Reverse recovery time	t_{rr}				25 125 150		15,13 15,51 15,64			ns
Recovered charge	Q_r	$di/dt=4162$ A/μs $di/dt=4717$ A/μs $di/dt=4994$ A/μs	±15	600	135	25 125 150	0,271 0,273 0,272			μC
Reverse recovered energy	E_{rec}				25 125 150		0,033 0,033 0,033			mWs
Peak rate of fall of recovery current	$(di_r/dt)_{max}$				25 125 150		10460,35 8703,36 7469,31			A/μs



Vincotech

Characteristic Values

Parameter	Symbol	Conditions					Values			Unit
		V_{GE} [V] V_{GS} [V]	V_{CE} [V] V_{DS} [V] V_F [V]	I_C [A] I_D [A] I_F [A]	T_j [°C]	Min	Typ	Max		

Outer Boost Sw. Protection Diode

Static

Forward voltage	V_F				75	25 125 150		1,74 1,83 1,84	2,15 ⁽¹⁾	V
Reverse leakage current	I_R	$V_r = 1200$ V				25			55	μA

Thermal

Thermal resistance junction to sink ⁽²⁾	$R_{th(j-s)}$	$\lambda_{paste} = 5,2$ W/mK (PTM)						0,79		K/W
--	---------------	---------------------------------------	--	--	--	--	--	------	--	-----

Aux Diode H

Static

Forward voltage	V_F				50	25 125 150		2,22 2,31 2,21	2,54 ⁽¹⁾ 2,5 ⁽¹⁾	V
Reverse leakage current	I_R	$V_r = 1200$ V				25 150		4400	60 8800	μA

Thermal

Thermal resistance junction to sink ⁽²⁾	$R_{th(j-s)}$	$\lambda_{paste} = 5,2$ W/mK (PTM)						1,04		K/W
--	---------------	---------------------------------------	--	--	--	--	--	------	--	-----



Characteristic Values

Parameter	Symbol	Conditions					Values			Unit
		V_{GE} [V] V_{GS} [V]	V_{CE} [V] V_{DS} [V] V_F [V]	I_C [A] I_D [A] I_F [A]	T_j [°C]	Min	Typ	Max		

Aux Diode L

Static

Forward voltage	V_F				50	25 125 150		2,22 2,31 2,21	2,54 ⁽¹⁾ 2,5 ⁽¹⁾	V
Reverse leakage current	I_R	$V_r = 1200$ V				25 150		4400	60 8800	μA

Thermal

Thermal resistance junction to sink ⁽²⁾	$R_{th(j-s)}$	$\lambda_{paste} = 5,2$ W/mK (PTM)						1,04		K/W
--	---------------	---------------------------------------	--	--	--	--	--	------	--	-----

Thermistor

Static

Rated resistance	R					25		22		kΩ
Deviation of R100	$\Delta_{R/R}$	$R_{100} = 1484$ Ω				100	-5		5	%
Power dissipation	P					25		130		mW
Power dissipation constant	d					25		1,5		mW/K
B-value	$B_{(25/50)}$	Tol. ±1 %						3962		K
B-value	$B_{(25/100)}$	Tol. ±1 %						4000		K
Vincotech Thermistor Reference									I	

⁽¹⁾ Value at chip level

⁽²⁾ Only valid with pre-applied Vincotech thermal interface material.



Inner Boost Switch Characteristics

figure 1. IGBT

Typical output characteristics

$$I_C = f(V_{CE})$$

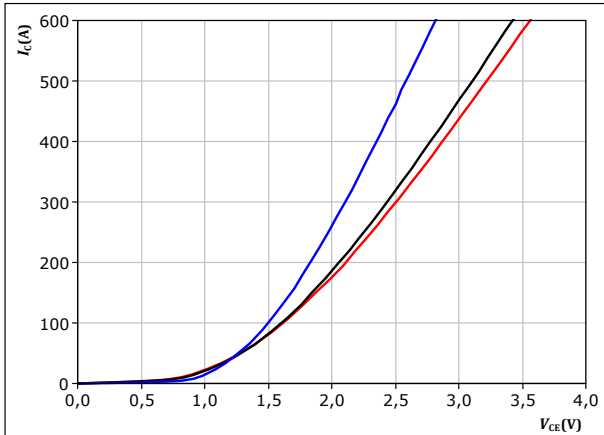

$t_p = 250 \mu s$
 $V_{GE} = 15 V$
 $T_j:$ — 25 °C
— 125 °C
— 150 °C

figure 2. IGBT

Typical output characteristics

$$I_C = f(V_{CE})$$

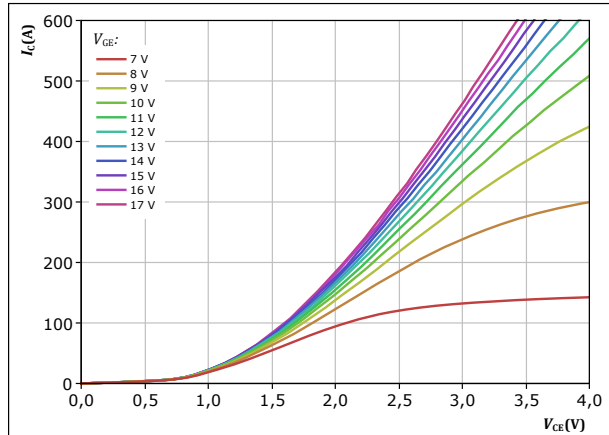

$t_p = 250 \mu s$
 $T_j = 150 \text{ °C}$
 V_{GE} from 7 V to 17 V in steps of 1 V

figure 3. IGBT

Typical transfer characteristics

$$I_C = f(V_{GE})$$

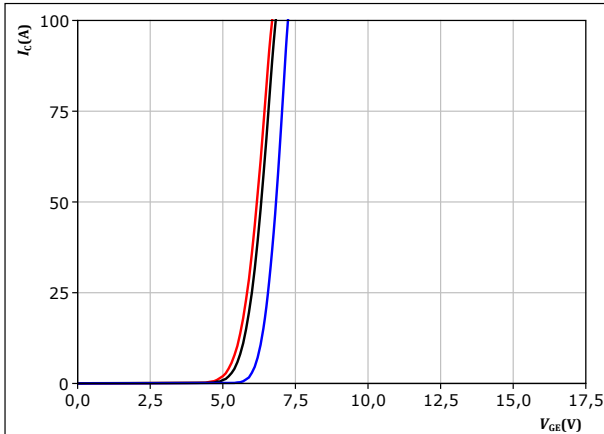

$t_p = 250 \mu s$
 $V_{CE} = 8 V$
 $T_j:$ — 25 °C
— 125 °C
— 150 °C

figure 4. IGBT

Transient thermal impedance as a function of pulse width

$$Z_{th(j-s)} = f(t_p)$$

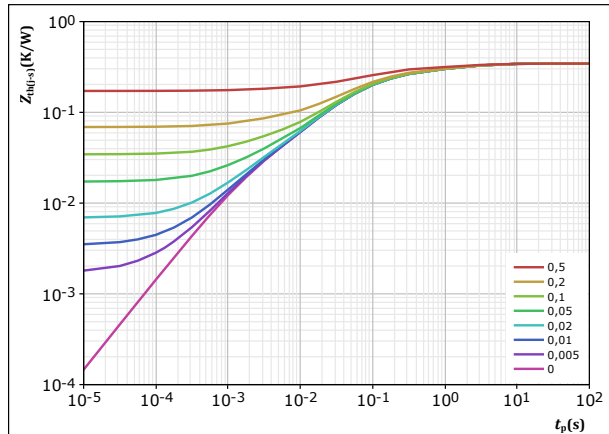

$D = t_p / T$
 $R_{th(j-s)} = 0,344 \text{ K/W}$
IGBT thermal model values

R (K/W)	τ (s)
3,51E-02	3,52E+00
6,84E-02	7,05E-01
1,60E-01	8,54E-02
6,50E-02	1,97E-02
1,61E-02	1,73E-03



Inner Boost Switch Characteristics

figure 5. IGBT

Safe operating area

$$I_C = f(V_{CE})$$

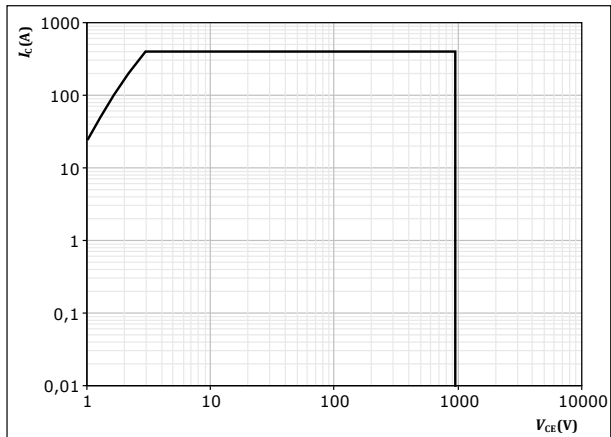

$D =$ single pulse

$T_s = 80$ °C

$V_{GE} = 15$ V

$T_j = T_{jmax}$



Inner Boost Diode Characteristics

figure 6. FWD

Typical forward characteristics

$$I_F = f(V_F)$$

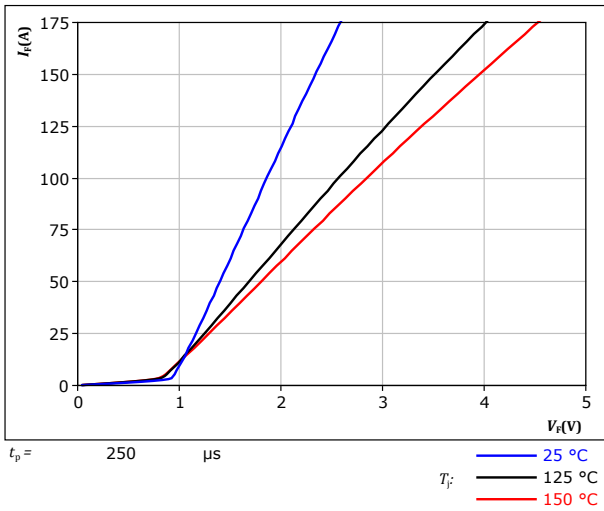
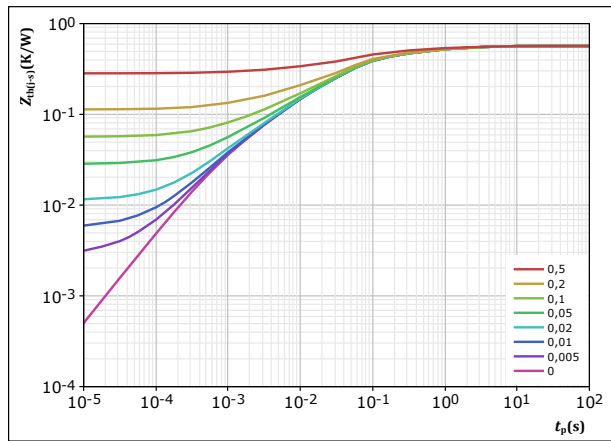

figure 7. FWD

Transient thermal impedance as a function of pulse width

$$Z_{th(j-s)} = f(t_p)$$



$D =$	t_p / T	
$R_{th(j-s)} =$	0,566	K/W
FWD thermal model values		
R (K/W)	τ (s)	
6,09E-02	2,27E+00	
1,15E-01	3,23E-01	
2,90E-01	4,74E-02	
7,95E-02	5,40E-03	
2,18E-02	7,49E-04	



Inner Boost Sw. Protection Diode Characteristics

figure 8. FWD

Typical forward characteristics

$$I_F = f(V_F)$$

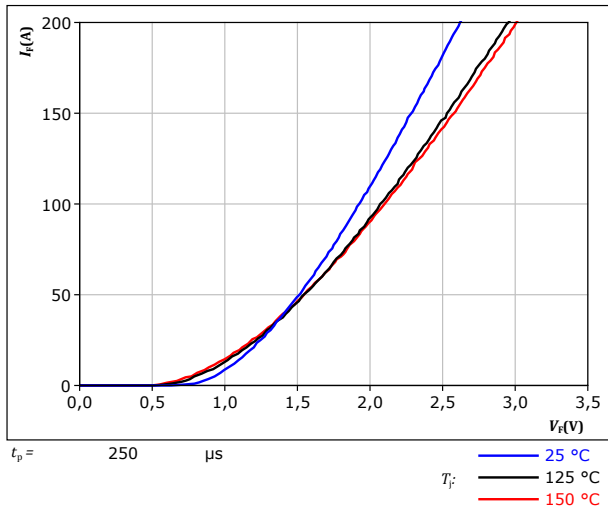
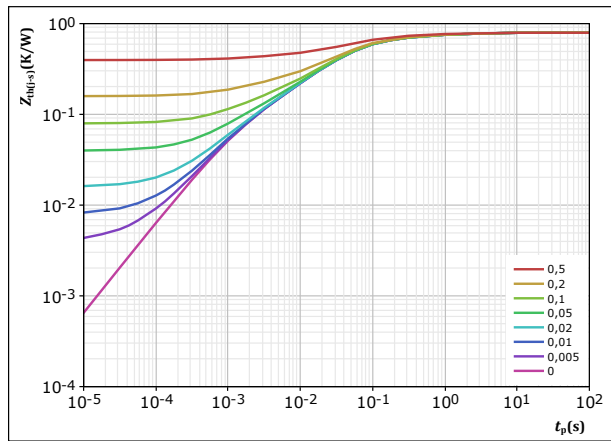

figure 9. FWD

Transient thermal impedance as a function of pulse width

$$Z_{th(j-s)} = f(t_p)$$



$D = \frac{t_p}{T}$
 $R_{th(j-s)} = 0,793 \text{ K/W}$
 FWD thermal model values

R (K/W)	τ (s)
5,39E-02	2,49E+00
1,33E-01	2,82E-01
4,13E-01	4,97E-02
1,37E-01	1,07E-02
5,71E-02	1,31E-03



Outer Boost Switch Characteristics

figure 10. IGBT

Typical output characteristics

$$I_C = f(V_{CE})$$

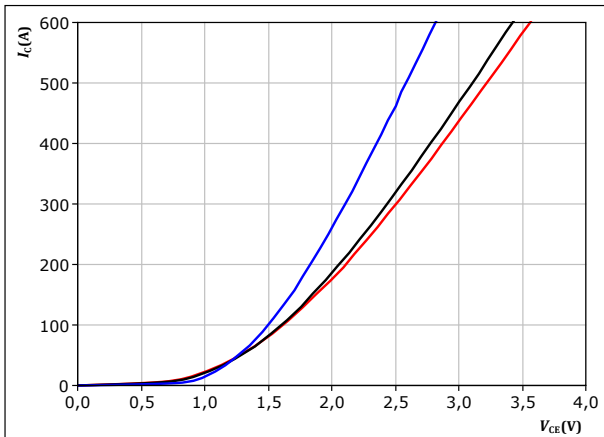

$t_p = 250 \mu s$
 $V_{GE} = 15 V$
 $T_j:$ — 25 °C
— 125 °C
— 150 °C

figure 11. IGBT

Typical output characteristics

$$I_C = f(V_{CE})$$

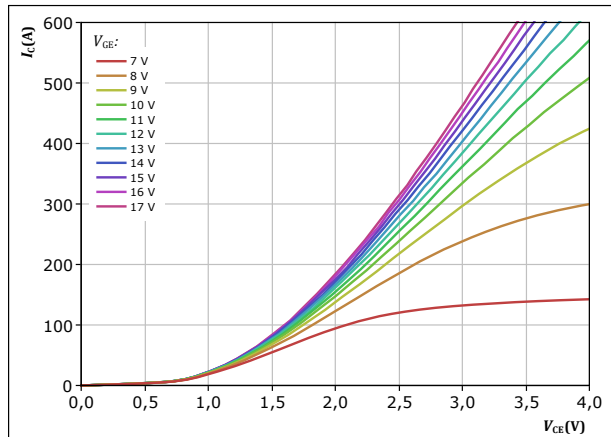

$t_p = 250 \mu s$
 $T_j = 150 \text{ °C}$
 V_{GE} from 7 V to 17 V in steps of 1 V

figure 12. IGBT

Typical transfer characteristics

$$I_C = f(V_{GE})$$

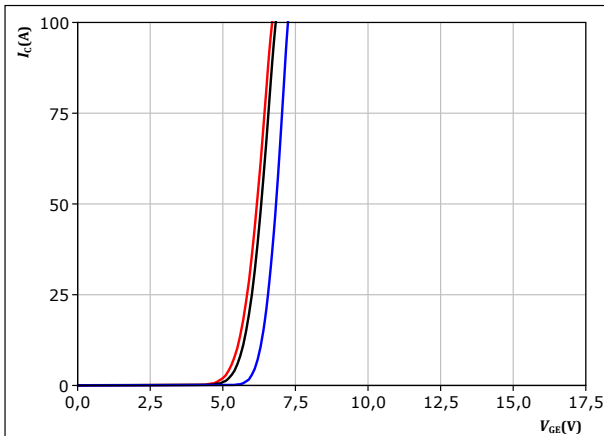

$t_p = 250 \mu s$
 $V_{CE} = 8 V$
 $T_j:$ — 25 °C
— 125 °C
— 150 °C

figure 13. IGBT

Transient thermal impedance as a function of pulse width

$$Z_{th(j-s)} = f(t_p)$$

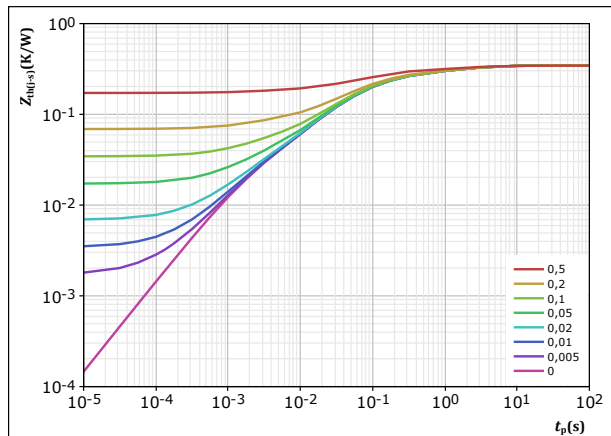

$D = t_p / T$
 $R_{th(j-s)} = 0,344 \text{ K/W}$
IGBT thermal model values

R (K/W)	τ (s)
3,51E-02	3,52E+00
6,84E-02	7,05E-01
1,60E-01	8,54E-02
6,50E-02	1,97E-02
1,61E-02	1,73E-03



Outer Boost Switch Characteristics

figure 14. IGBT

Safe operating area

$$I_C = f(V_{CE})$$

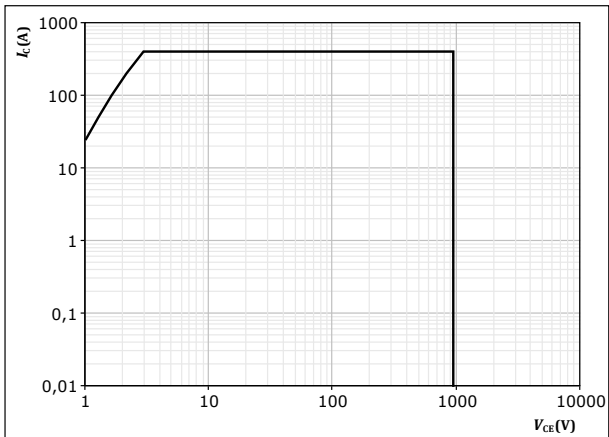

$D =$ single pulse

$T_s = 80$ °C

$V_{CE} = 15$ V

$T_j = T_{jmax}$



Outer Boost Diode Characteristics

figure 15. FWD

Typical forward characteristics

$$I_F = f(V_F)$$

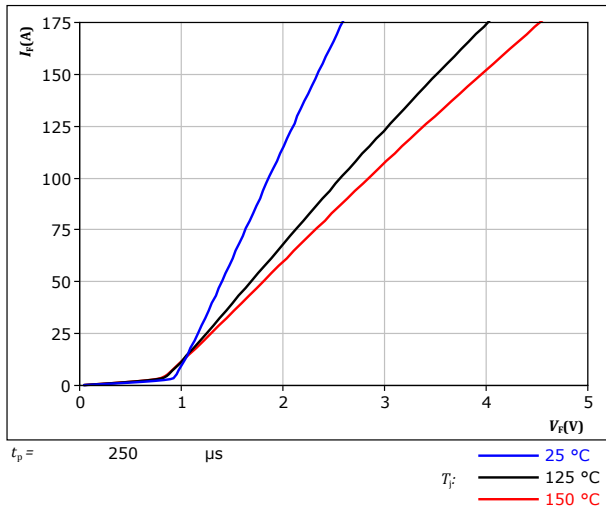
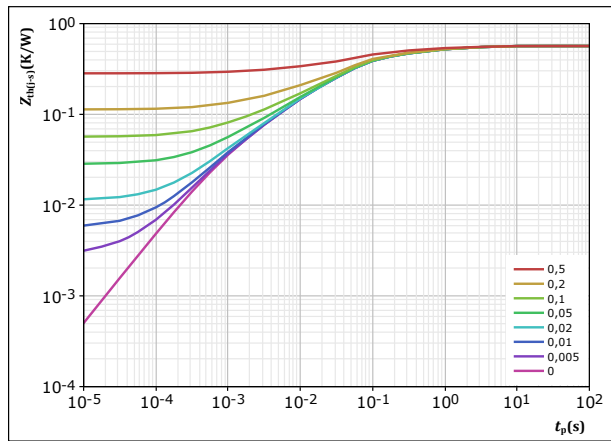

figure 16. FWD

Transient thermal impedance as a function of pulse width

$$Z_{th(j-s)} = f(t_p)$$



$D = t_p / T$
 $R_{th(j-s)} = 0,566 \text{ K/W}$
 FWD thermal model values

R (K/W)	τ (s)
6,09E-02	2,27E+00
1,15E-01	3,23E-01
2,90E-01	4,74E-02
7,95E-02	5,40E-03
2,18E-02	7,49E-04



Outer Boost Sw. Protection Diode Characteristics

figure 17. FWD

Typical forward characteristics

$$I_F = f(V_F)$$

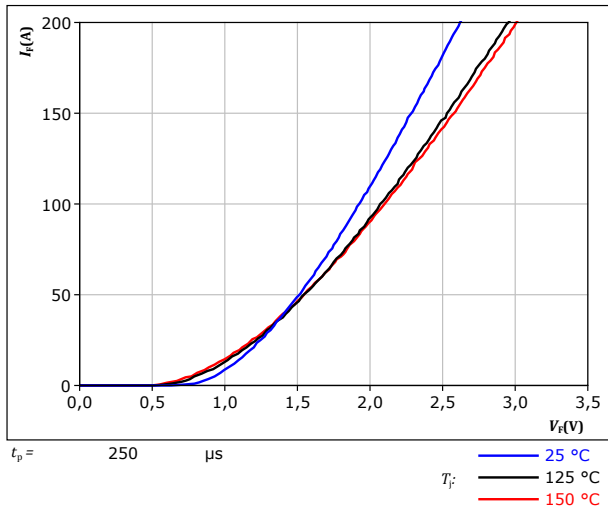
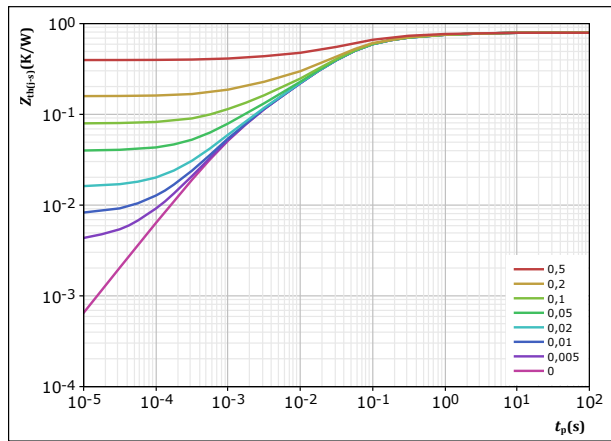

figure 18. FWD

Transient thermal impedance as a function of pulse width

$$Z_{th(j-s)} = f(t_p)$$



$D = t_p / T$
 $R_{th(j-s)} = 0,793 \text{ K/W}$
 FWD thermal model values

R (K/W)	τ (s)
5,39E-02	2,49E+00
1,33E-01	2,82E-01
4,13E-01	4,97E-02
1,37E-01	1,07E-02
5,71E-02	1,31E-03



Aux Diode H Characteristics

figure 19. FWD

Typical forward characteristics

$$I_F = f(V_F)$$

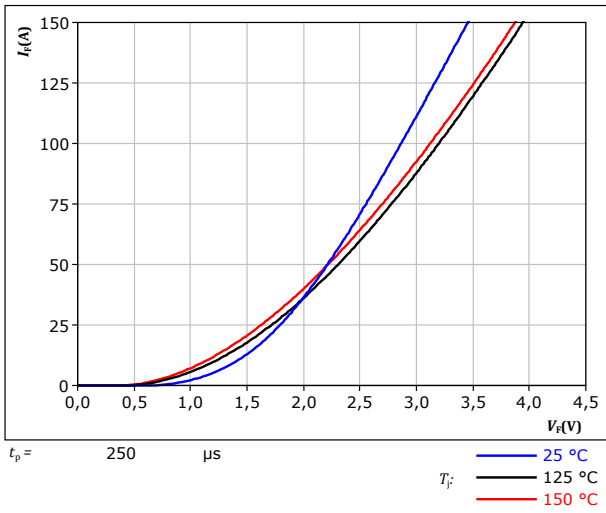
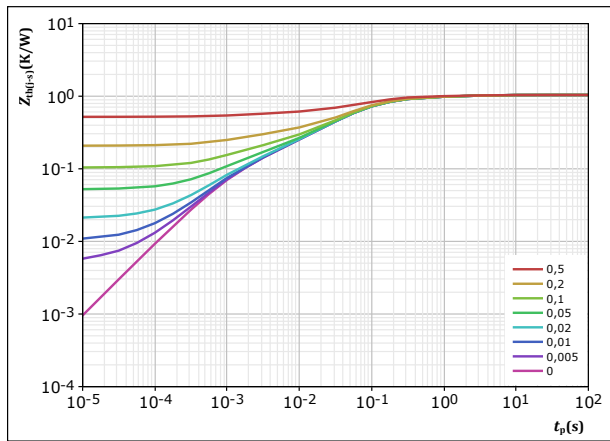

figure 20. FWD

Transient thermal impedance as a function of pulse width

$$Z_{th(j-s)} = f(t_p)$$



$D = \frac{t_p}{T}$
 $R_{th(j-s)} = 1,04 \text{ K/W}$
 FWD thermal model values

R (K/W)	τ (s)
6,44E-02	2,63E+00
1,36E-01	3,97E-01
6,27E-01	6,88E-02
1,30E-01	9,91E-03
8,29E-02	1,13E-03



Aux Diode L Characteristics

figure 21. FWD

Typical forward characteristics

$$I_F = f(V_F)$$

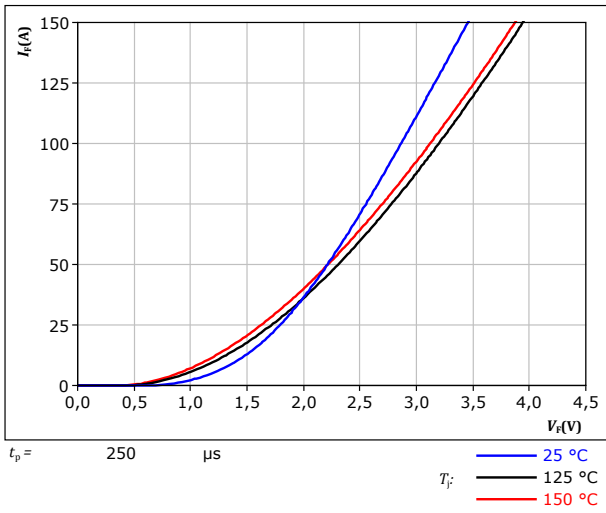
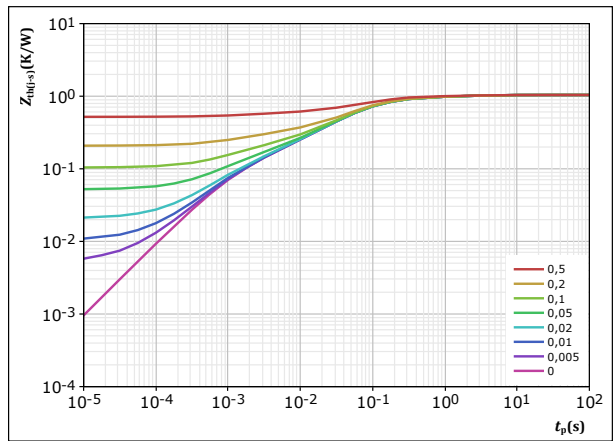

figure 22. FWD

Transient thermal impedance as a function of pulse width

$$Z_{th(j-s)} = f(t_p)$$



$D = \frac{t_p}{T}$
 $R_{th(j-s)} = 1,04 \text{ K/W}$
 FWD thermal model values

R (K/W)	τ (s)
6,44E-02	2,63E+00
1,36E-01	3,97E-01
6,27E-01	6,88E-02
1,30E-01	9,91E-03
8,29E-02	1,13E-03



Thermistor Characteristics

figure 23. Thermistor

Typical NTC characteristic as function of temperature

$$R_T = f(T)$$

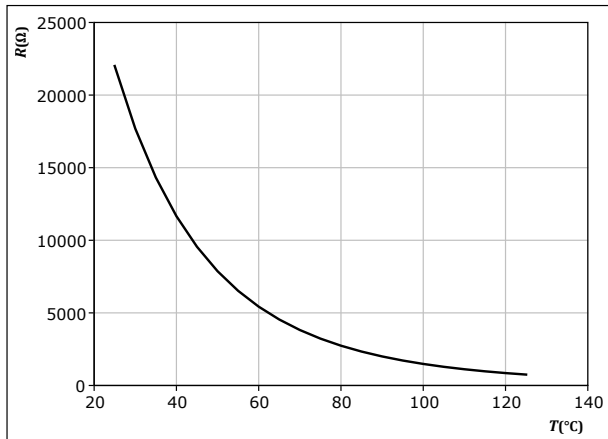



Inner Boost Switching Characteristics

figure 24. IGBT

Typical switching energy losses as a function of collector current
 $E = f(I_c)$

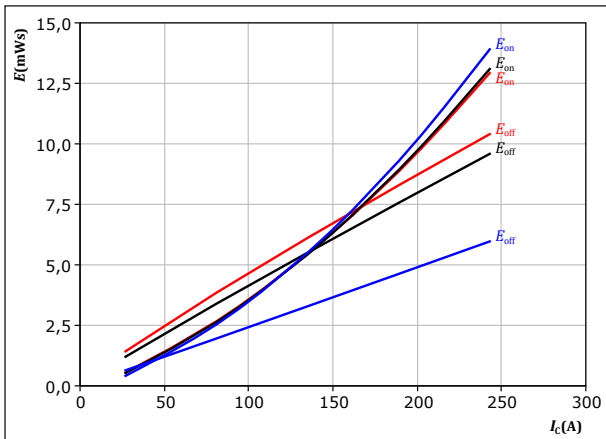

With an inductive load at

$V_{CE} = 600 \text{ V}$
 $V_{GE} = \pm 15 \text{ V}$
 $R_{g(on)} = 8 \ \Omega$
 $R_{g(off)} = 8 \ \Omega$

T_j : — 25 °C
 — 125 °C
 — 150 °C

figure 25. IGBT

Typical switching energy losses as a function of IGBT turn on gate resistor
 $E = f(R_g)$

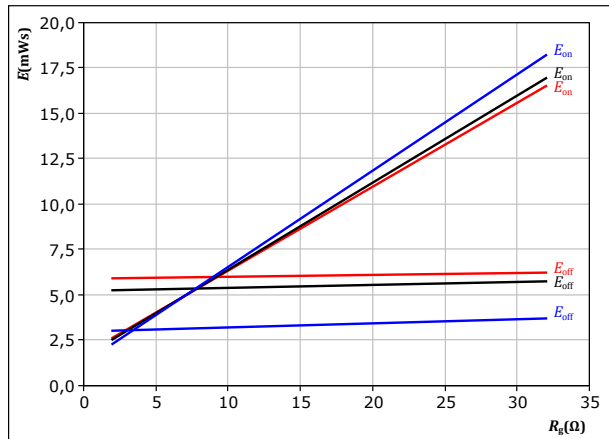

With an inductive load at

$V_{CE} = 600 \text{ V}$
 $V_{GE} = \pm 15 \text{ V}$
 $I_c = 135 \text{ A}$

T_j : — 25 °C
 — 125 °C
 — 150 °C

figure 26. FWD

Typical reverse recovered energy loss as a function of collector current
 $E_{rec} = f(I_c)$

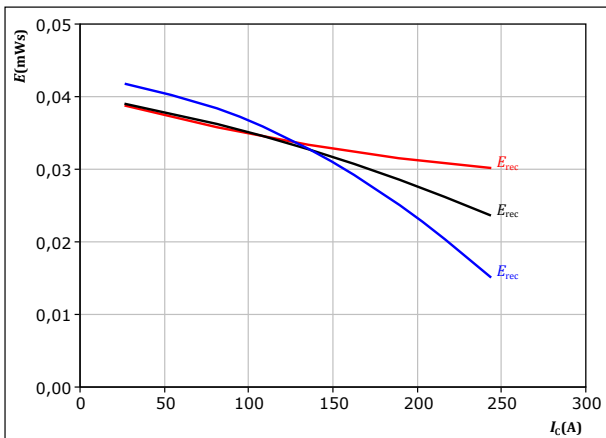

With an inductive load at

$V_{CE} = 600 \text{ V}$
 $V_{GE} = \pm 15 \text{ V}$
 $R_{g(on)} = 8 \ \Omega$

T_j : — 25 °C
 — 125 °C
 — 150 °C

figure 27. FWD

Typical reverse recovered energy loss as a function of IGBT turn on gate resistor
 $E_{rec} = f(R_g)$

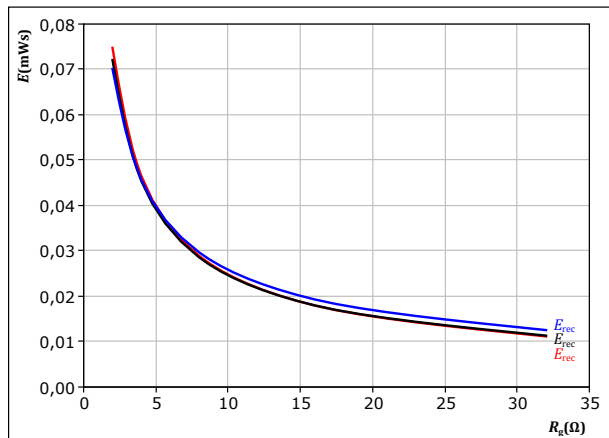

With an inductive load at

$V_{CE} = 600 \text{ V}$
 $V_{GE} = \pm 15 \text{ V}$
 $I_c = 135 \text{ A}$

T_j : — 25 °C
 — 125 °C
 — 150 °C



Inner Boost Switching Characteristics

figure 28. IGBT

Typical switching times as a function of collector current
 $t = f(I_c)$

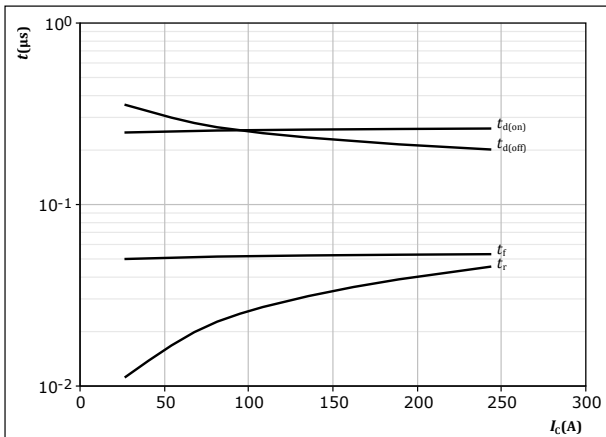

With an inductive load at
 $T_j = 150 \text{ }^\circ\text{C}$
 $V_{CE} = 600 \text{ V}$
 $V_{GE} = \pm 15 \text{ V}$
 $R_{gon} = 8 \text{ } \Omega$
 $R_{goff} = 8 \text{ } \Omega$

figure 29. IGBT

Typical switching times as a function of IGBT turn on gate resistor
 $t = f(R_g)$

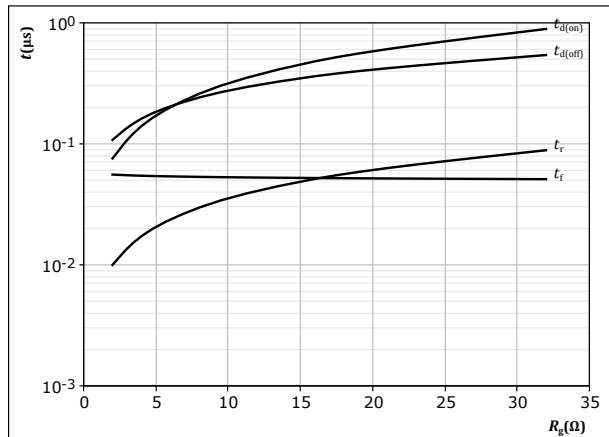

With an inductive load at
 $T_j = 150 \text{ }^\circ\text{C}$
 $V_{CE} = 600 \text{ V}$
 $V_{GE} = \pm 15 \text{ V}$
 $I_c = 135 \text{ A}$

figure 30. FWD

Typical reverse recovery time as a function of collector current
 $t_{rr} = f(I_c)$

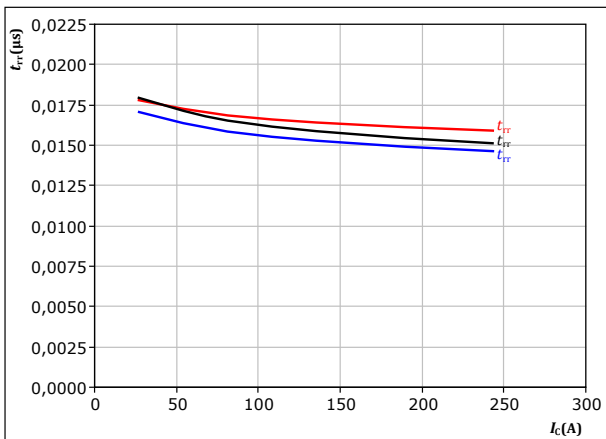

With an inductive load at
 $V_{CE} = 600 \text{ V}$
 $V_{GE} = \pm 15 \text{ V}$
 $R_{gon} = 8 \text{ } \Omega$
 $T_j:$ — 25 °C
 — 125 °C
 — 150 °C

figure 31. FWD

Typical reverse recovery time as a function of IGBT turn on gate resistor
 $t_{rr} = f(R_{gon})$

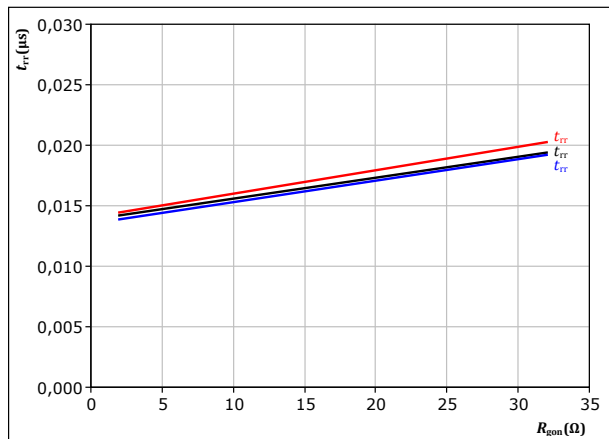

With an inductive load at
 $V_{CE} = 600 \text{ V}$
 $V_{GE} = \pm 15 \text{ V}$
 $I_c = 135 \text{ A}$
 $T_j:$ — 25 °C
 — 125 °C
 — 150 °C



Inner Boost Switching Characteristics

figure 32. FWD

Typical recovered charge as a function of collector current

$$Q_r = f(I_c)$$

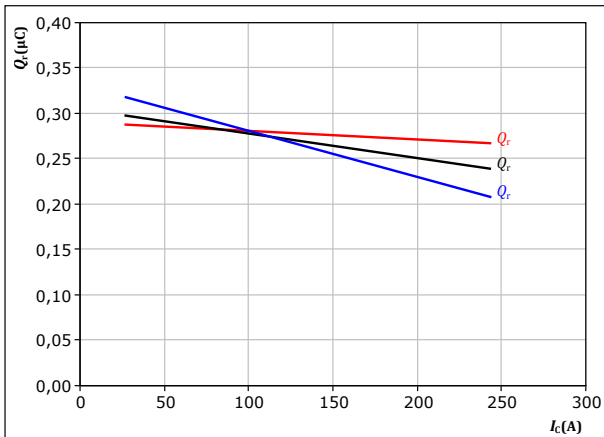

With an inductive load at

$V_{CE} =$	600	V	$T_j:$	— 25 °C
$V_{GE} =$	±15	V		— 125 °C
$R_{gon} =$	8	Ω		— 150 °C

figure 34. FWD

Typical peak reverse recovery current as a function of collector current

$$I_{RM} = f(I_c)$$

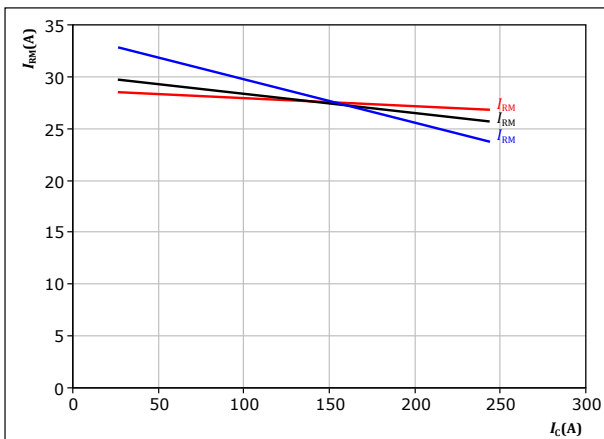

With an inductive load at

$V_{CE} =$	600	V	$T_j:$	— 25 °C
$V_{GE} =$	±15	V		— 125 °C
$R_{gon} =$	8	Ω		— 150 °C

figure 33. FWD

Typical recovered charge as a function of IGBT turn on gate resistor

$$Q_r = f(R_{gon})$$

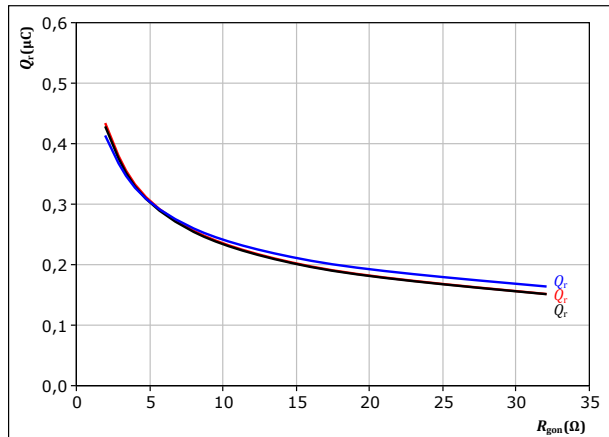

With an inductive load at

$V_{CE} =$	600	V	$T_j:$	— 25 °C
$V_{GE} =$	±15	V		— 125 °C
$I_c =$	135	A		— 150 °C

figure 35. FWD

Typical peak reverse recovery current as a function of IGBT turn on gate resistor

$$I_{RM} = f(R_{gon})$$

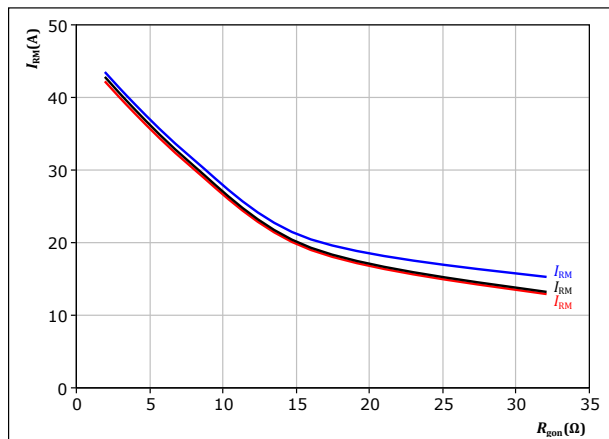

With an inductive load at

$V_{CE} =$	600	V	$T_j:$	— 25 °C
$V_{GE} =$	±15	V		— 125 °C
$I_c =$	135	A		— 150 °C



Inner Boost Switching Characteristics

figure 36. FWD

Typical rate of fall of forward and reverse recovery current as a function of collector current
 $di_f/dt, di_{rr}/dt = f(I_C)$

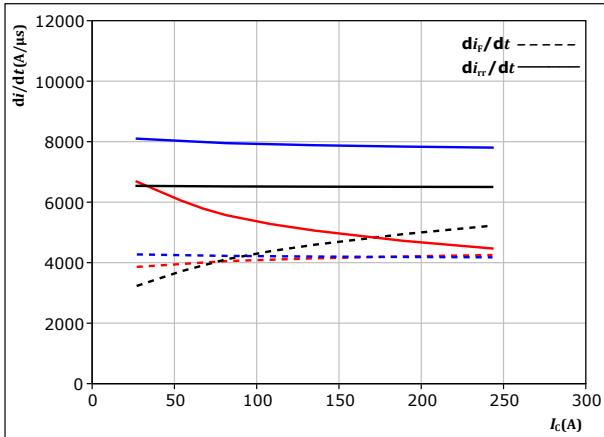

With an inductive load at

$V_{CE} = 600 \text{ V}$
 $V_{GE} = \pm 15 \text{ V}$
 $R_{gon} = 8 \ \Omega$

T_j : 25 °C
 125 °C
 150 °C

figure 37. FWD

Typical rate of fall of forward and reverse recovery current as a function of turn on gate resistor
 $di_f/dt, di_{rr}/dt = f(R_{gon})$

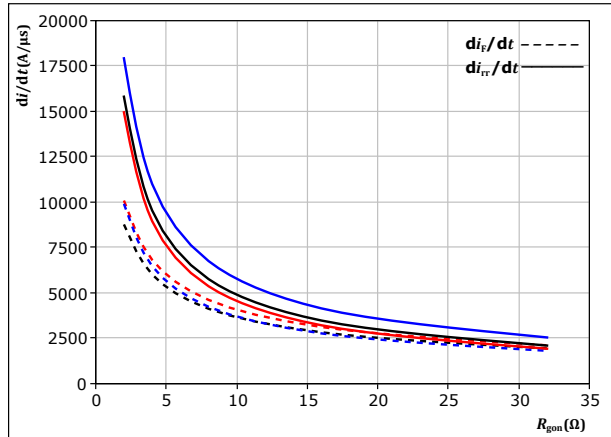

With an inductive load at

$V_{CE} = 600 \text{ V}$
 $V_{GE} = \pm 15 \text{ V}$
 $I_C = 135 \text{ A}$

T_j : 25 °C
 125 °C
 150 °C

figure 38. IGBT

Reverse bias safe operating area

$I_C = f(V_{CE})$

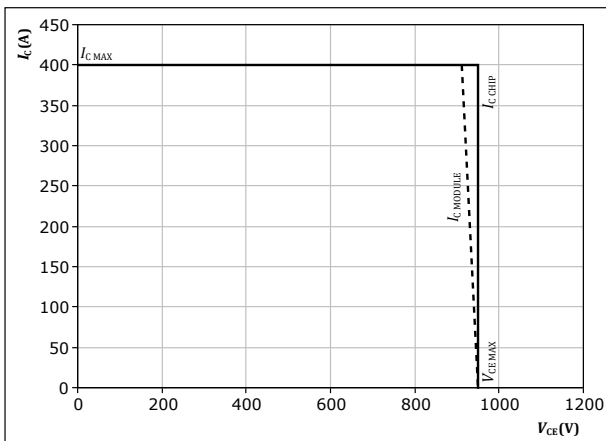

At $T_j = 150 \text{ °C}$
 $R_{gon} = 8 \ \Omega$
 $R_{goff} = 8 \ \Omega$



Outer Boost Switching Characteristics

figure 39. IGBT

Typical switching energy losses as a function of collector current
 $E = f(I_c)$

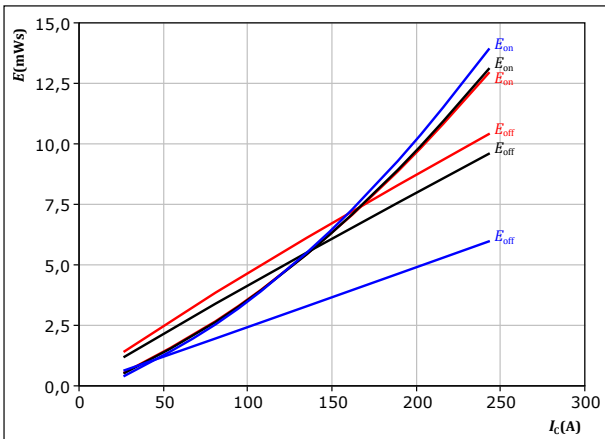

With an inductive load at

$V_{CE} = 600 \text{ V}$
 $V_{GE} = \pm 15 \text{ V}$
 $R_{g(on)} = 8 \ \Omega$
 $R_{g(off)} = 8 \ \Omega$

T_j : — 25 °C
 — 125 °C
 — 150 °C

figure 40. IGBT

Typical switching energy losses as a function of IGBT turn on gate resistor
 $E = f(R_g)$

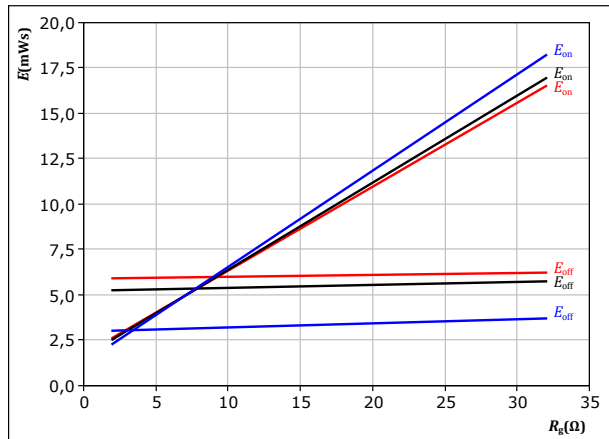

With an inductive load at

$V_{CE} = 600 \text{ V}$
 $V_{GE} = \pm 15 \text{ V}$
 $I_c = 135 \text{ A}$

T_j : — 25 °C
 — 125 °C
 — 150 °C

figure 41. FWD

Typical reverse recovered energy loss as a function of collector current
 $E_{rec} = f(I_c)$

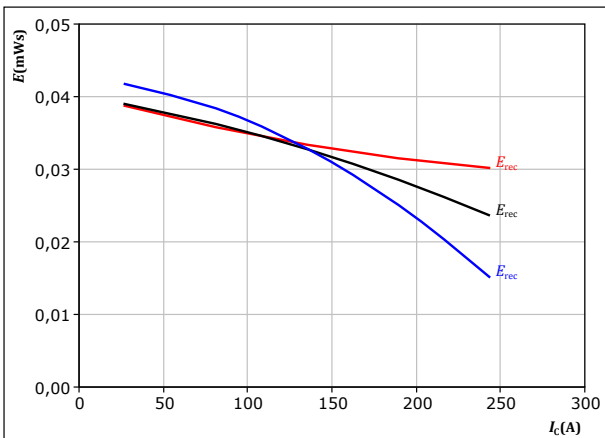

With an inductive load at

$V_{CE} = 600 \text{ V}$
 $V_{GE} = \pm 15 \text{ V}$
 $R_{g(on)} = 8 \ \Omega$

T_j : — 25 °C
 — 125 °C
 — 150 °C

figure 42. FWD

Typical reverse recovered energy loss as a function of IGBT turn on gate resistor
 $E_{rec} = f(R_g)$

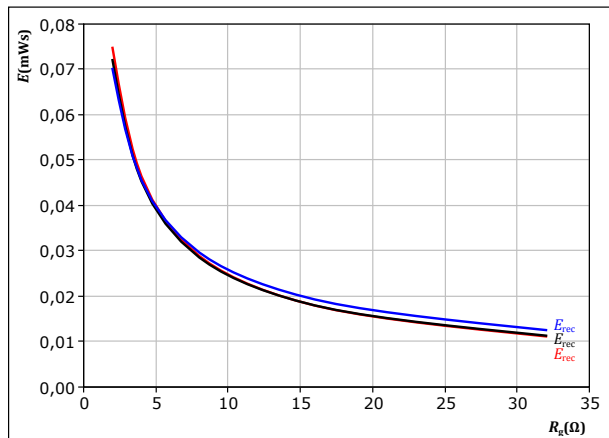

With an inductive load at

$V_{CE} = 600 \text{ V}$
 $V_{GE} = \pm 15 \text{ V}$
 $I_c = 135 \text{ A}$

T_j : — 25 °C
 — 125 °C
 — 150 °C



Outer Boost Switching Characteristics

figure 43. IGBT

Typical switching times as a function of collector current
 $t = f(I_c)$

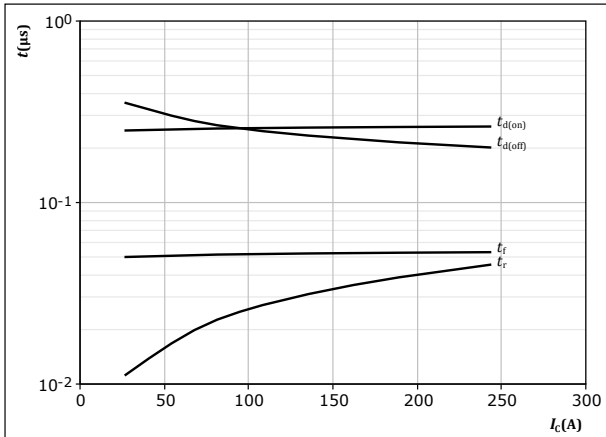

With an inductive load at
 $T_j = 150 \text{ }^\circ\text{C}$
 $V_{CE} = 600 \text{ V}$
 $V_{GE} = \pm 15 \text{ V}$
 $R_{gon} = 8 \text{ } \Omega$
 $R_{goff} = 8 \text{ } \Omega$

figure 44. IGBT

Typical switching times as a function of IGBT turn on gate resistor
 $t = f(R_g)$

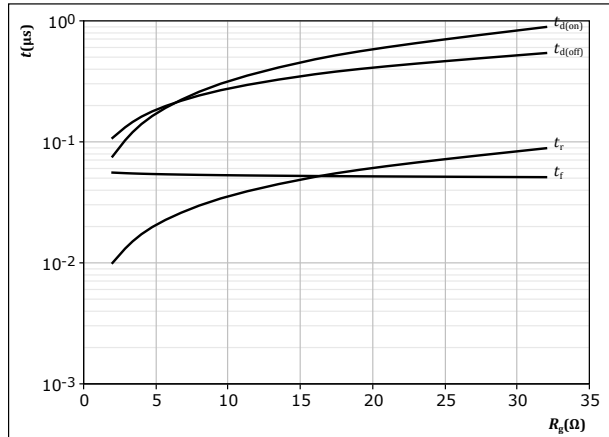

With an inductive load at
 $T_j = 150 \text{ }^\circ\text{C}$
 $V_{CE} = 600 \text{ V}$
 $V_{GE} = \pm 15 \text{ V}$
 $I_c = 135 \text{ A}$

figure 45. FWD

Typical reverse recovery time as a function of collector current
 $t_{rr} = f(I_c)$

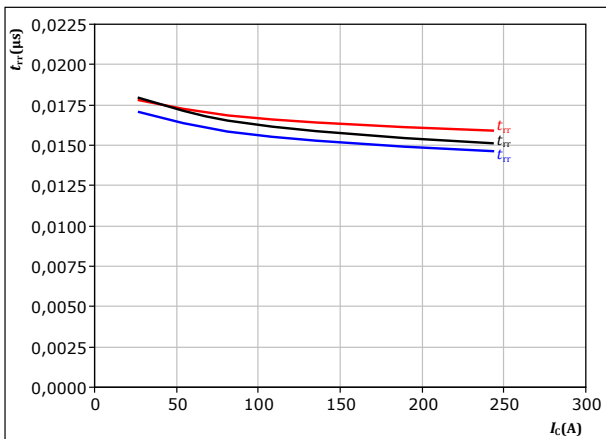

With an inductive load at
 $V_{CE} = 600 \text{ V}$
 $V_{GE} = \pm 15 \text{ V}$
 $R_{gon} = 8 \text{ } \Omega$
 $T_j:$ — 25 °C
— 125 °C
— 150 °C

figure 46. FWD

Typical reverse recovery time as a function of IGBT turn on gate resistor
 $t_{rr} = f(R_{gon})$

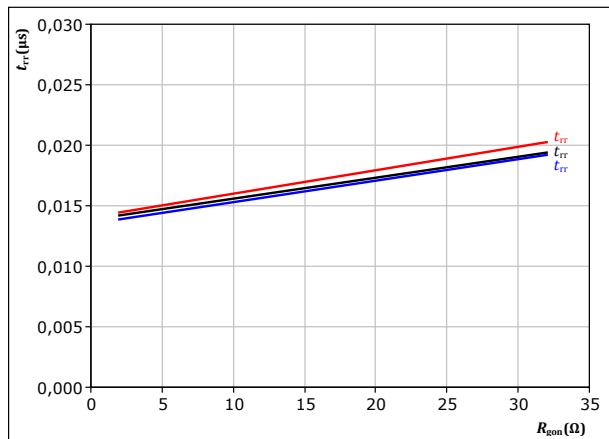

With an inductive load at
 $V_{CE} = 600 \text{ V}$
 $V_{GE} = \pm 15 \text{ V}$
 $I_c = 135 \text{ A}$
 $T_j:$ — 25 °C
— 125 °C
— 150 °C



Outer Boost Switching Characteristics

figure 47. FWD

Typical recovered charge as a function of collector current

$$Q_r = f(I_c)$$

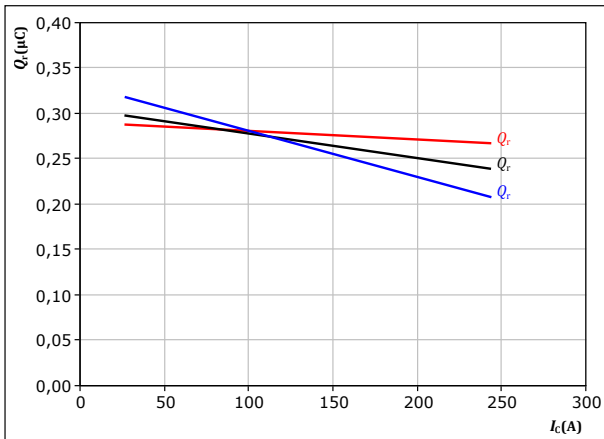

With an inductive load at

$V_{CE} = 600 \text{ V}$
 $V_{GE} = \pm 15 \text{ V}$
 $R_{gon} = 8 \ \Omega$

T_j : — 25 °C
— 125 °C
— 150 °C

figure 48. FWD

Typical recovered charge as a function of IGBT turn on gate resistor

$$Q_r = f(R_{gon})$$

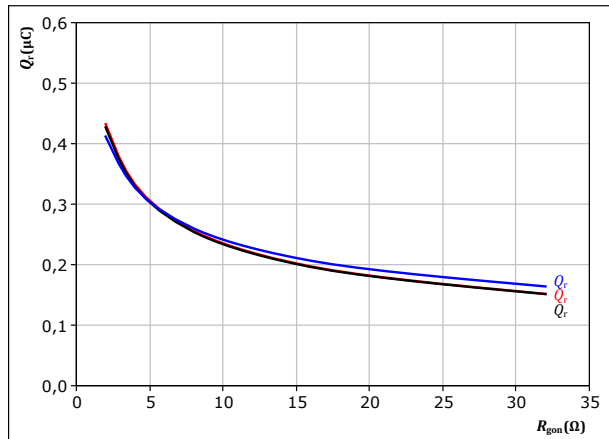

With an inductive load at

$V_{CE} = 600 \text{ V}$
 $V_{GE} = \pm 15 \text{ V}$
 $I_c = 135 \text{ A}$

T_j : — 25 °C
— 125 °C
— 150 °C

figure 49. FWD

Typical peak reverse recovery current as a function of collector current

$$I_{RM} = f(I_c)$$

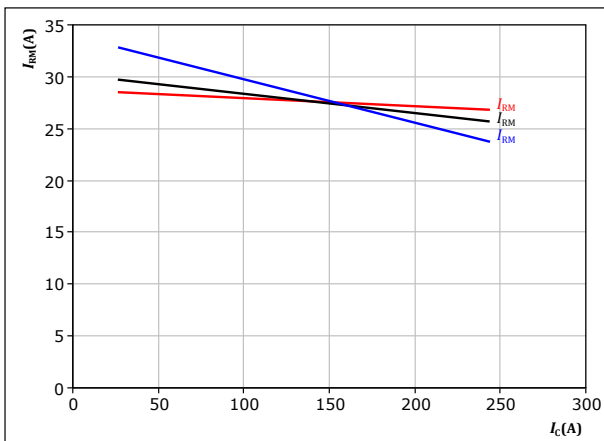

With an inductive load at

$V_{CE} = 600 \text{ V}$
 $V_{GE} = \pm 15 \text{ V}$
 $R_{gon} = 8 \ \Omega$

T_j : — 25 °C
— 125 °C
— 150 °C

figure 50. FWD

Typical peak reverse recovery current as a function of IGBT turn on gate resistor

$$I_{RM} = f(R_{gon})$$

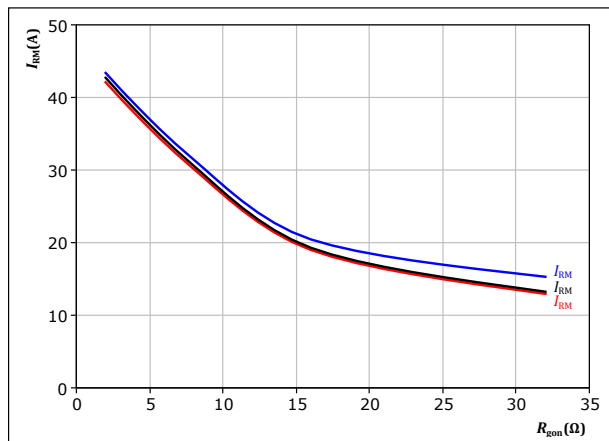

With an inductive load at

$V_{CE} = 600 \text{ V}$
 $V_{GE} = \pm 15 \text{ V}$
 $I_c = 135 \text{ A}$

T_j : — 25 °C
— 125 °C
— 150 °C



Outer Boost Switching Characteristics

figure 51. FWD

Typical rate of fall of forward and reverse recovery current as a function of collector current
 $di_f/dt, di_{rr}/dt = f(I_C)$

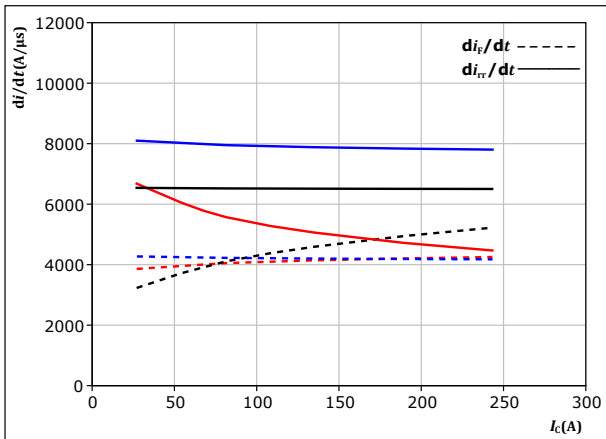

With an inductive load at

$V_{CE} = 600 \text{ V}$
 $V_{GE} = \pm 15 \text{ V}$
 $R_{gon} = 8 \ \Omega$

$T_j:$
— 25 °C
— 125 °C
— 150 °C

figure 52. FWD

Typical rate of fall of forward and reverse recovery current as a function of turn on gate resistor
 $di_f/dt, di_{rr}/dt = f(R_{gon})$

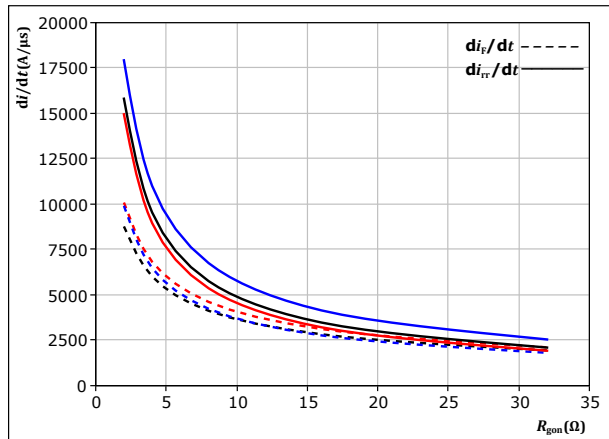

With an inductive load at

$V_{CE} = 600 \text{ V}$
 $V_{GE} = \pm 15 \text{ V}$
 $I_C = 135 \text{ A}$

$T_j:$
— 25 °C
— 125 °C
— 150 °C

figure 53. IGBT

Reverse bias safe operating area

$I_C = f(V_{CE})$

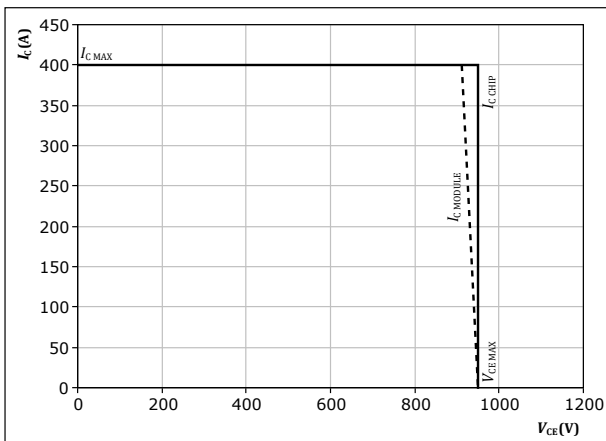

At $T_j = 150 \text{ °C}$
 $R_{gon} = 8 \ \Omega$
 $R_{goff} = 8 \ \Omega$



Switching Definitions

figure 54. IGBT

Turn-off Switching Waveforms & definition of t_{doff} , t_{Eoff} (t_{Eoff} = integrating time for E_{off})

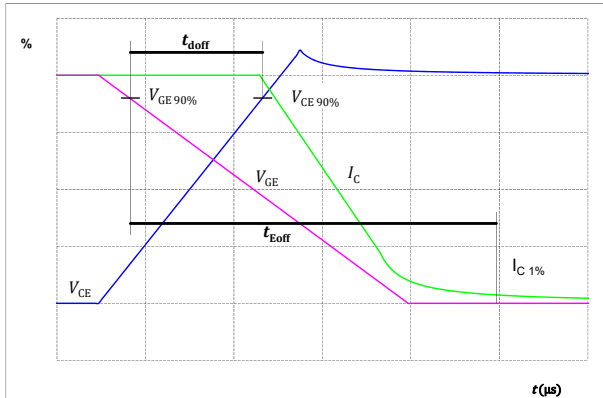

figure 55. IGBT

Turn-on Switching Waveforms & definition of t_{don} , t_{Eon} (t_{Eon} = integrating time for E_{on})

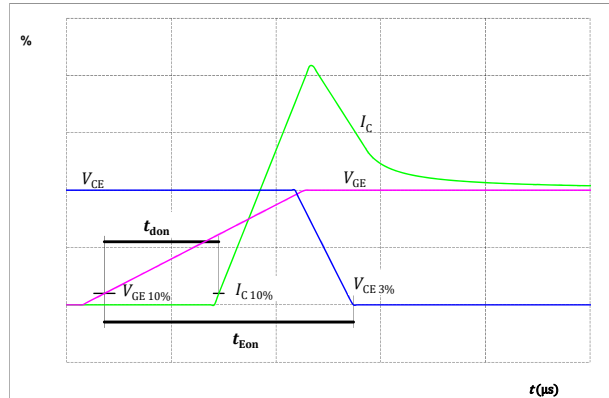

figure 56. IGBT

Turn-off Switching Waveforms & definition of t_f

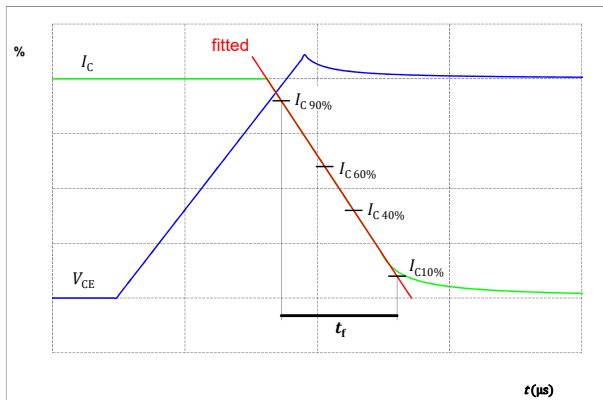
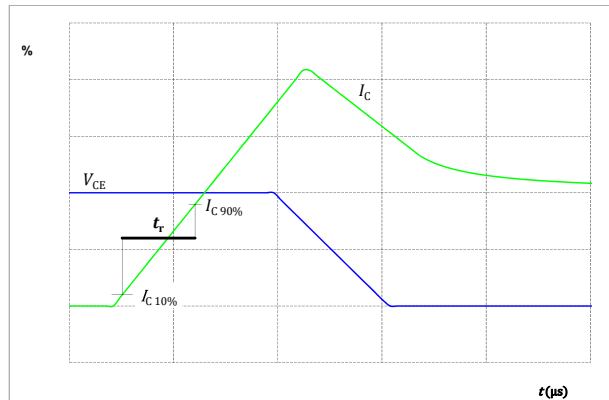

figure 57. IGBT

Turn-on Switching Waveforms & definition of t_r





Switching Definitions

figure 58. FWD

Turn-off Switching Waveforms & definition of t_{rr}

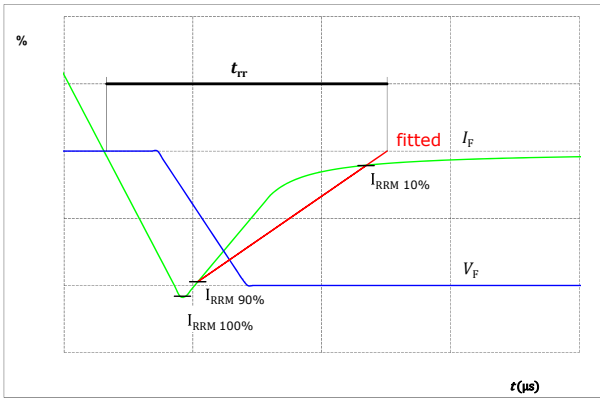
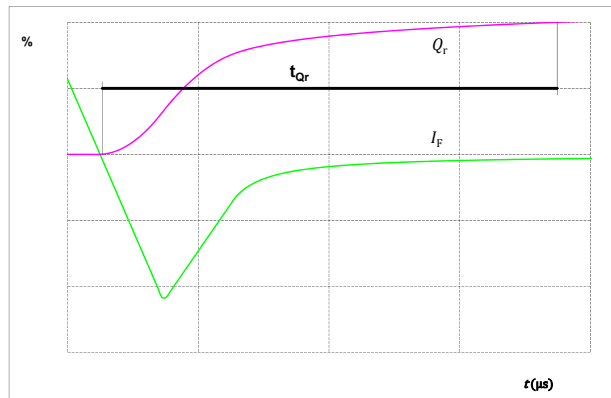

figure 59. FWD

Turn-on Switching Waveforms & definition of t_{Qr} (t_{Qr} = integrating time for Q_r)





Vincotech

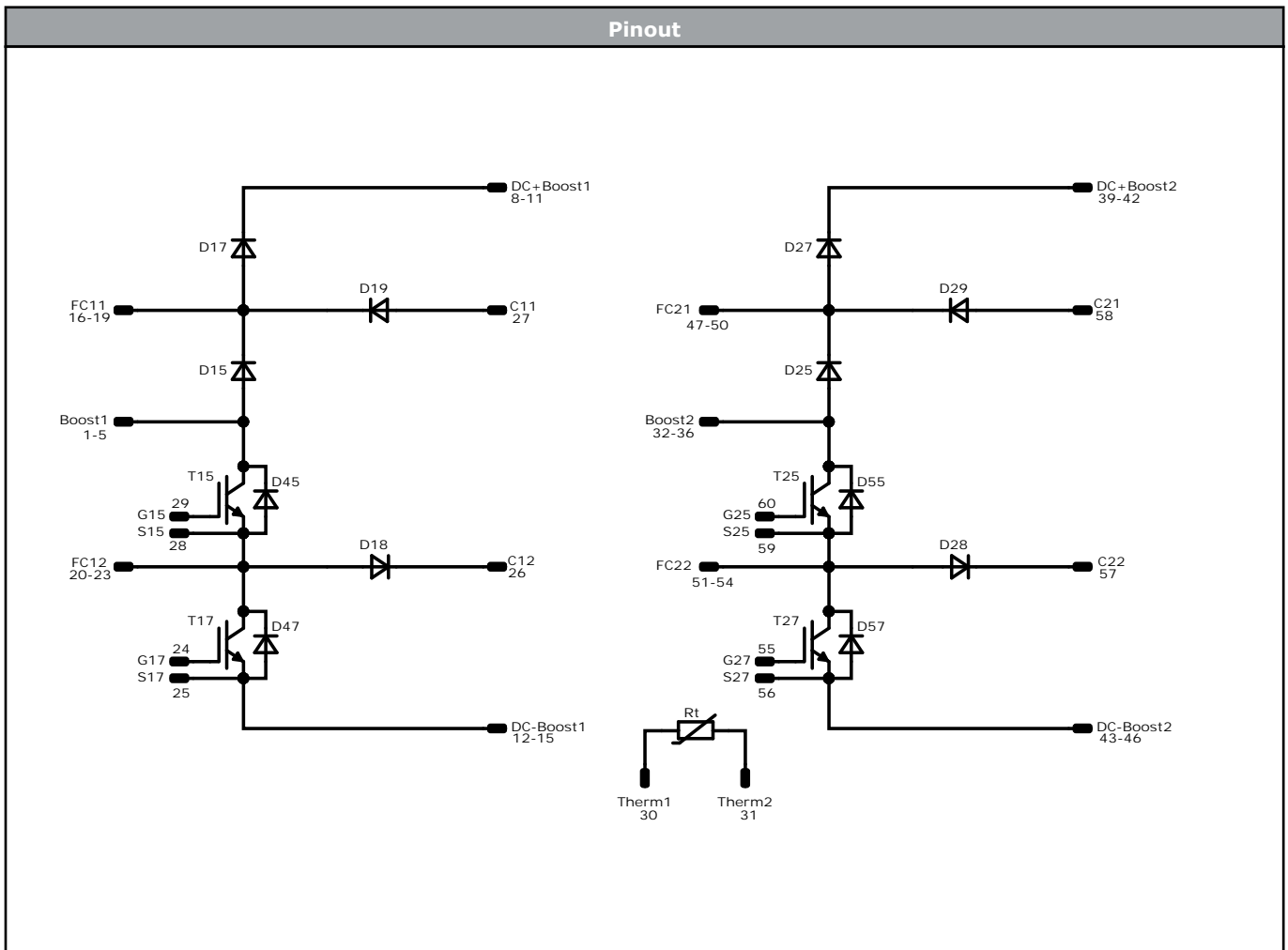

Identification					
ID	Component	Voltage	Current	Function	Comment
T15, T25	IGBT	950 V	200 A	Inner Boost Switch	
D15, D25	FWD	1200 V	60 A	Inner Boost Diode	
D45, D55	FWD	1200 V	75 A	Inner Boost Sw. Protection Diode	
T17, T27	IGBT	950 V	200 A	Outer Boost Switch	
D17, D27	FWD	1200 V	60 A	Outer Boost Diode	
D47, D57	FWD	1200 V	75 A	Outer Boost Sw. Protection Diode	
D19, D29	FWD	1200 V	50 A	Aux Diode H	
D18, D28	FWD	1200 V	50 A	Aux Diode L	
Rt	Thermistor			Thermistor	



Vincotech

Packaging instruction				
Standard packaging quantity (SPQ) 45	>SPQ	Standard	<SPQ	Sample

Handling instruction
Handling instructions for <i>flow</i> S3 packages see vincotech.com website.

Package data
Package data for <i>flow</i> S3 packages see vincotech.com website.

Vincotech thermistor reference
See Vincotech thermistor reference table at vincotech.com website.

Application Note
For use of pre-charging auxiliary diodes see application note: "The Advantages and Operation of Flying-Capacitor Boosters" at vincotech.com

UL recognition and file number
This device is certified according to UL 1557 standard, UL file number E192116. For more information see vincotech.com website. 

Document No.:	Date:	Modification:	Pages
B0-SP10B2A200S704-PA58L98T-D3-14	20 Jan. 2023	Without Capacitors	

DISCLAIMER

The information, specifications, procedures, methods and recommendations herein (together "information") are presented by Vincotech to reader in good faith, are believed to be accurate and reliable, but may well be incomplete and/or not applicable to all conditions or situations that may exist or occur. Vincotech reserves the right to make any changes without further notice to any products to improve reliability, function or design. No representation, guarantee or warranty is made to reader as to the accuracy, reliability or completeness of said information or that the application or use of any of the same will avoid hazards, accidents, losses, damages or injury of any kind to persons or property or that the same will not infringe third parties rights or give desired results. It is reader's sole responsibility to test and determine the suitability of the information and the product for reader's intended use.

LIFE SUPPORT POLICY

Vincotech products are not authorised for use as critical components in life support devices or systems without the express written approval of Vincotech.

As used herein:

1. Life support devices or systems are devices or systems which, (a) are intended for surgical implant into the body, or (b) support or sustain life, or (c) whose failure to perform when properly used in accordance with instructions for use provided in labelling can be reasonably expected to result in significant injury to the user.
2. A critical component is any component of a life support device or system whose failure to perform can be reasonably expected to cause the failure of the life support device or system, or to affect its safety or effectiveness.